

# **RWC5020x Application Program**

## **Operation Manual**

Version 1.320

April 2021

---

## Contents

I. Getting Started.....	4
1.1 Download and Installation .....	5
1.2 Starting the Application .....	7
1.3 Opening the Manual .....	8
1.4 Checking Upgrade .....	8
1.5 Checking License .....	9
1.6 GUI Structure .....	10
1.6.1 Test function windows .....	11
1.6.2 Report function windows.....	11
II. Menus .....	13
2.1 PROJECT .....	14
2.1.1 Project Menu.....	14
2.1.2 DUT menu .....	16
2.2 SETUP .....	18
2.2.1 Connect RWC5020x.....	18
2.2.2 Control DUT(ED).....	19
2.2.3 Control DUT(GW) .....	21
2.2.4 Parameter Configuration.....	22
2.2.5 Remote by Other host.....	29
2.2.6 Utility Environment .....	30
III. Test Functions .....	34
3.1 Pre-Certification Test.....	35
3.1.1 LoRaWAN® Pre-Certification .....	35
3.1.2 Operator Certification .....	36
3.1.3 Pre-Certification Test Items.....	36
3.2 Performance Test .....	40
3.2.1 PER & POWER .....	40
3.2.2 LBT TEST .....	48
3.2.3 NON-REGRESSION TEST .....	50
3.3 Link Analyzer .....	57
3.3.1 Saving link message.....	58
3.3.2 Payload editor .....	58
3.3.3 Script editor.....	68
3.4 Functions.....	72

3.4.1 MFG (Manufacturing).....	72
3.4.2 NST SG (Signal Generator).....	77
3.4.3 NST SA (Signal Analyzer).....	80
3.4.4 FUOTA Test .....	81
3.5 Utilities .....	85
3.5.1 DUT Control.....	85
3.5.2 RWC5020x Control .....	86
3.5.3 Screen Capture.....	88
IV. Report Functions.....	89
4.1 Report File Manager .....	90
4.1.1 Creating Report .....	90
4.1.2 How to Open the Saved Report File .....	91

# I. Getting Started

This chapter explains how to download and start RWC5020x application program.

- 1.1 Download and Installation
- 1.2 Starting the Application
- 1.3 Opening the Manual
- 1.4 Checking Upgrade
- 1.5 Checking License
- 1.6 GUI Structure

## 1.1 Download and Installation

RWC5020x application program is provided through email or download link and the downloaded file can be unzipped into users' directory. The following figures show an example.

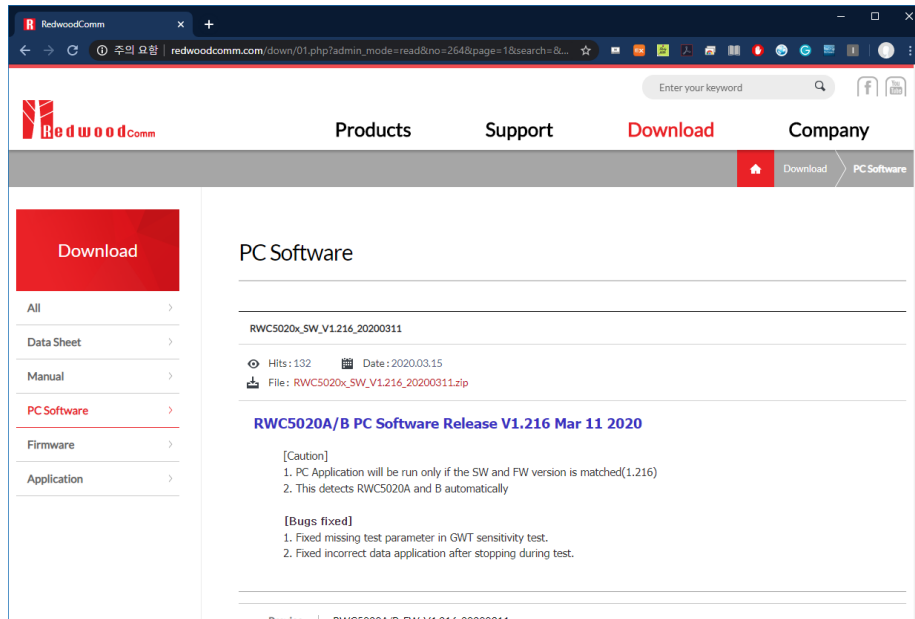

Fig 1.1 Downloading Zip file from the RedwoodComm website

Unzip the zip file and install the executable file as the install wizard guides.

You can install it in other directories as you like as well.

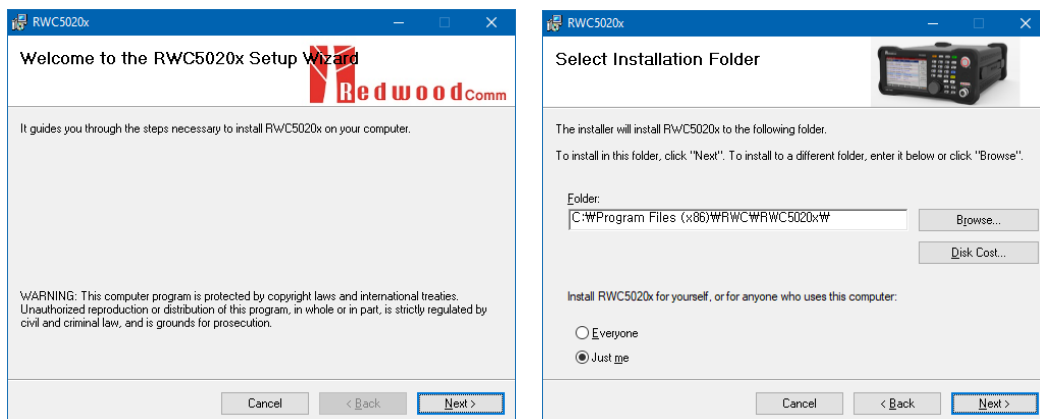

Fig 1.2 Installation wizard

After installation, you can see directories and files as follows (Figure 1.3)

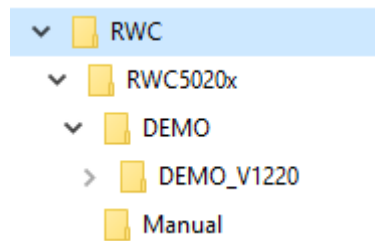

Fig 1.3 Installed directory structure

In directory RWC5020x /

Executable file RWC5020x\_App.exe

Dll files

DEMO directory

Manual directory

In directory DEMO /

An example demo project data: DEMO\_Vxxx0.prj and the same named directory

In directory DEMO\_V1220/

Example DUTs : dut\_name.ini and the same named directories

In directory manual

App\_release\_note.pdf

Fw\_release\_note.pdf

Application\_manul.pdf

FW\_manul.pdf

---

**Note:** PC's OS

1. Windows is supported, but Linux and IOS are not supported.
2. Users are recommended to use windows7 or later version as OS.
3. If you want to avoid the authorization problem with your OS system, please install this application on non-system disk, such as 'D drive'.

Language setup

1. Users are strongly recommended to use '' than ;' for floating expression.
  2. Users are strongly recommended to use ;' than '' for decimal expression.
  3. Users are strongly recommended to use English over other languages.
-

## 1.2 Starting the Application

When you execute the application 'RWC5020x\_App.exe', it will start as shown in the figure 1.4.

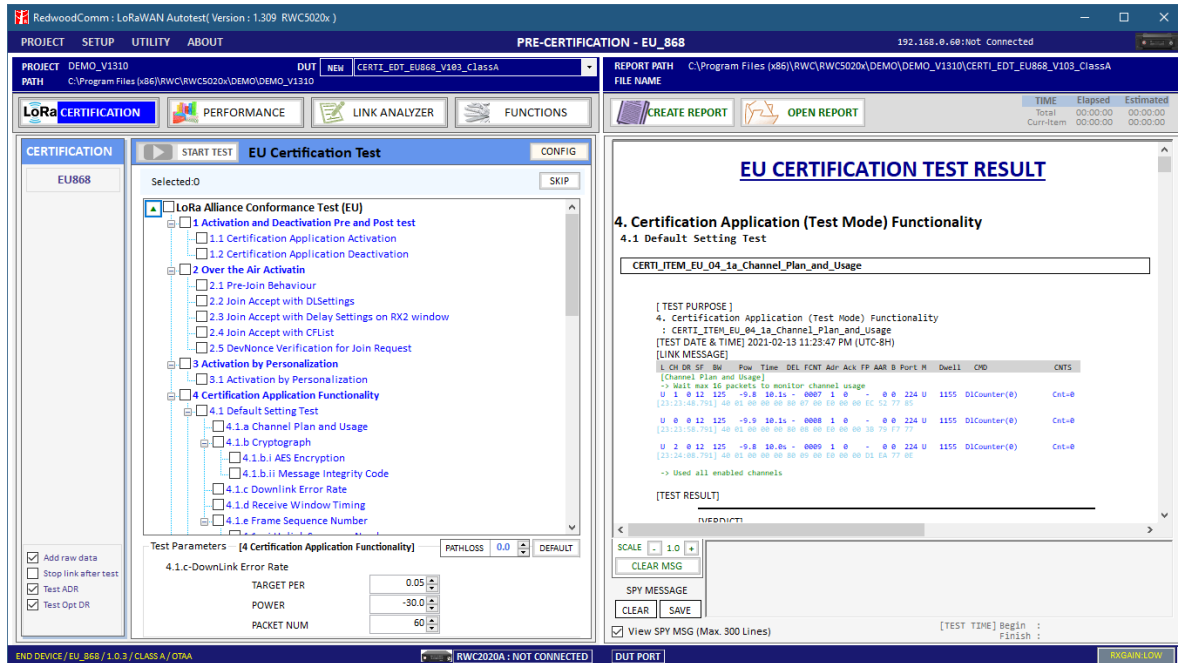

Fig 1.4 Initial screen of the application

You can see the SW version and model name. When connected with the equipment, you can see the correct equipment types (RWC5020A, B, or M).

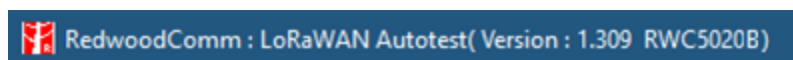



Fig 1.5 Title message of RWC5020 application

To connect the application to RWC5020x, click on **192.168.0.100:Not Connected** or  icon. This will bring up the pop-up window.

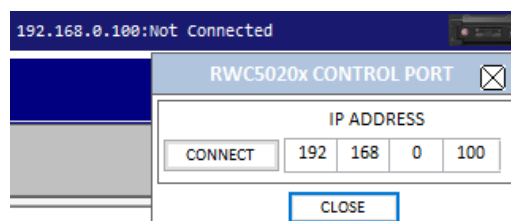

Fig 1.6 RWC5020x CONTROL PORT WINDOW

If there is no RWC5020x connected to exact IP, an alert message window will be pop up as shown in the figure 1.7

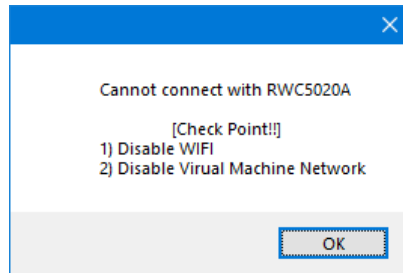

Fig 1.7 Pop-up Message for no connection alert

For safe connection, users are recommended to connect their PC to RWC 5020x via wired LAN.

If there is an RWC5020x connected to correct IP, you can see ID string that includes name, FW version, and serial.

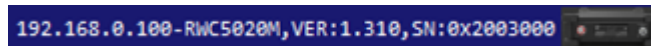

Fig 1.8 ID string of RWC5020x

## 1.3 Opening the Manual

Clicking [Manual] will show the operation manual of this application

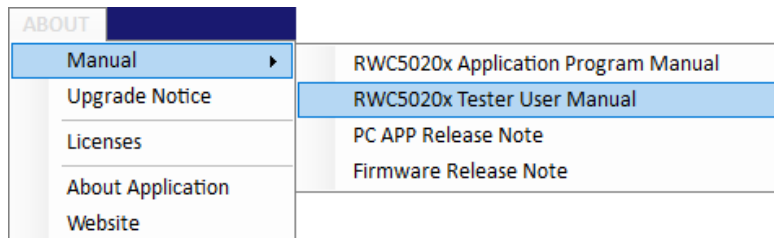

Fig 1.9 Opening the manual

## 1.4 Checking Upgrade

You can check the latest version of this application program using [Upgrade Notice] menu.

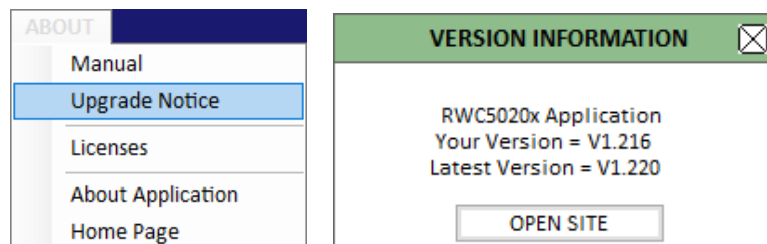

Fig 1.10 Upgrade Notice menu and information window



Clicking on [OPEN SITE] button will open up the download webpage of RedwoodComm.

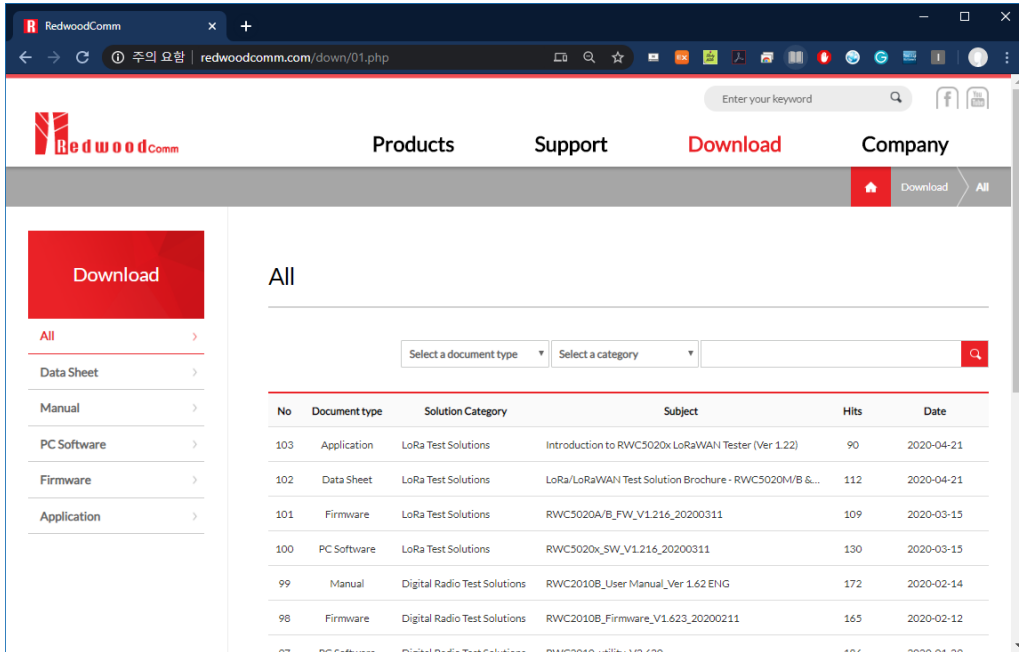

Fig 1.11 Download page of RedwoodComm webpage

## 1.5 Checking License

After connecting with RWC5020x, users can see the licenses of RWC5020x by clicking on Licenses menu. More regional licensed can be listed according to the version.

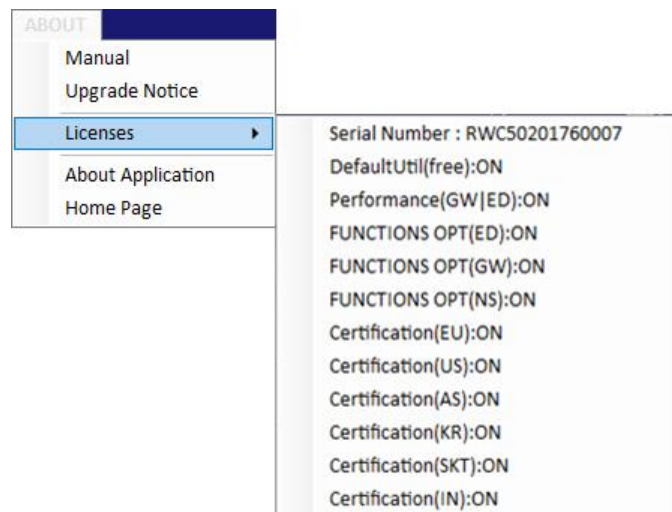

Fig 1.12 Licenses of RWC5020x

## 1.6 GUI Structure

RWC5020x application program consists of three classified functional windows: Project menu windows, Test functions windows, and Report functions windows. In the following figure, the functions in the blue-colored box are project menu windows, and the windows in the red-colored box are test related ones, and the windows in the green-colored box are report related ones. The next chapters will include the detail explanation about each window respectively.

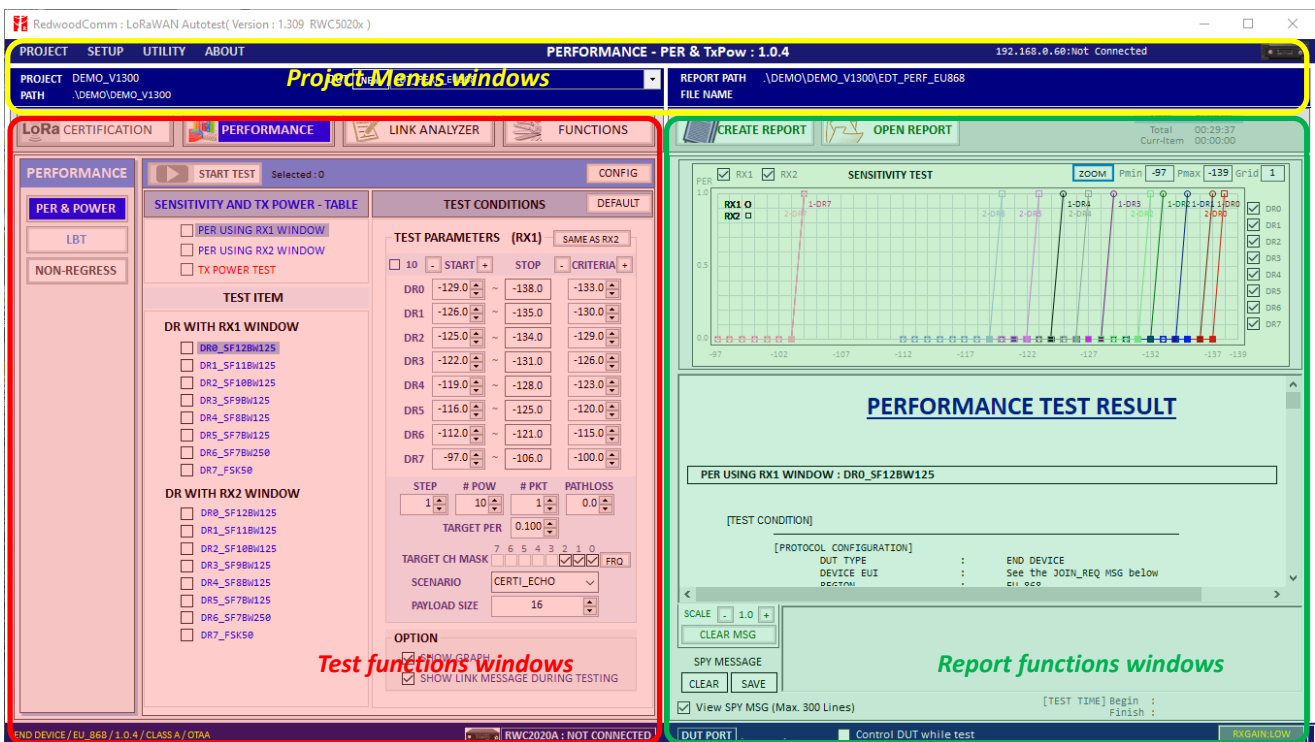

Fig 1.13 Function window classification

This application consists of 4 classified functions such as LoRaWAN® pre-certification test, performance test, Link analyzer, and functionalities (figure 1.14).



Fig 1.14 Main menu buttons

### 1.6.1 Test function windows

You can select one of the test function windows using main menu buttons (figure 1.15).

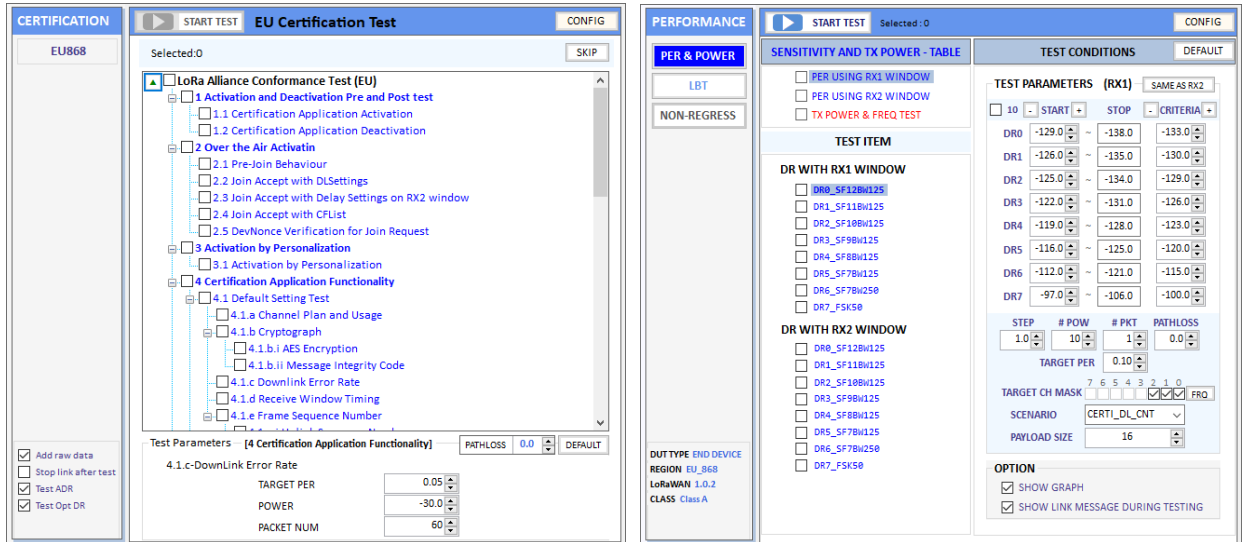

a. Pre-Certification Test Window

b. Performance Test Window

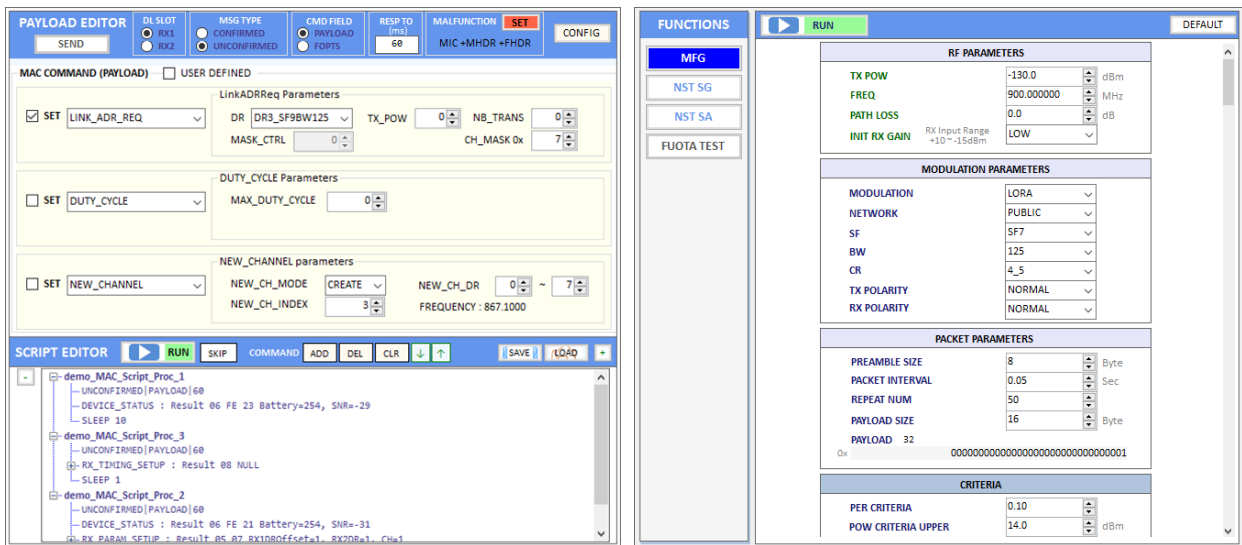

c. Link Analyzer Window

d. Functionality Test Window

Fig 1.15 Test function window

### 1.6.2 Report function windows

The report function windows have different functions from the test functions. If you click on one of the main menu buttons, test function window will appear on the left side and report function window will appear on the right side (figure 1.16).

CREATE REPORT OPEN REPORT TIME Elapsed Estimated  
Total: 00:00:00 Curr-Item: 00:00:00

### LORA CERTIFICATION TEST SUMMARY (EU V1.6)

ITEMS	VERDICT	SUB VERDICT
<b>1 Activation and Deactivation Pre and Post test</b>	<b>PASS</b>	
1.1 Certification Application Activation	PASS	PASS
1.2 Certification Application Deactivation	PASS	PASS
<b>2 Over the Air Activation</b>	<b>PASS</b>	
2.1 Pre-Join Behaviour	PASS	
2.2 Join Accept with DLSettings	PASS	
2.3 Join Accept with Delay Settings on RX2 window	PASS	
2.4 Join Accept with CFList	PASS	
2.5 DevNonce Verification for Join Request	PASS	
<b>3 Activation by Personalization</b>	<b>PASS</b>	
3.1 Activation by Personalization	PASS	PASS
<b>4 Certification Application Functionality</b>	<b>PASS</b>	
4.1 Default Setting Test	PASS	
4.1.a Channel Plan and Usage		PASS
4.1.b Cryptograph	PASS	
4.1.b.i AES Encryption		PASS
4.1.b.ii Message Integrity Code		PASS
4.1.c Downlink Error Rate		PASS
4.1.d Receive Window Timing		PASS
4.1.e Frame Sequence Number	PASS	
4.1.e.i Uplink Sequence Number		PASS
4.1.e.ii Downlink Sequence Number		PASS
4.1.e.iii Downlink Sequence Number Rollover		PASS
4.2 Confirmed Frames	PASS	
4.2.a Confirmed Uplinks		PASS
4.2.b Confirmed Uplink Retransmission		PASS

View SPY MSG (Max. 300 Lines) 1.0 CLEAR MSG [TEST TIME] Begin : Finish :

DUT PORT RXGAIN LOW

CREATE REPORT OPEN REPORT TIME Elapsed  
Total: 00:29:37 Curr-Item: 00:00:00

### SENSITIVITY TEST

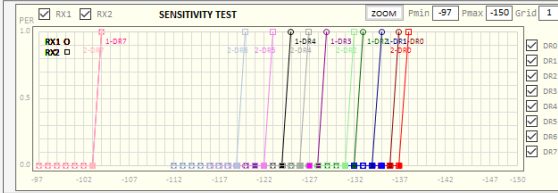

### PERFORMANCE TEST SUMMARY

OUT NAME: EDT\_PERF\_EU868  
REGION: EU\_868

PER USING RX1 WINDOW : PASS

DR	Start	Step	Stop	Target	#Pkt	Criteria	Result	Verdict
DR0	-129.0	1.0	-138.0	0.100	1	-133	-136.0/0.000	PASS
DR1	-126.0	1.0	-135.0	0.100	1	-130	-134.0/0.000	PASS
DR2	-125.0	1.0	-134.0	0.100	1	-129	-132.0/0.000	PASS
DR3	-122.0	1.0	-131.0	0.100	1	-126	-128.0/0.000	PASS
DR4	-119.0	1.0	-128.0	0.100	1	-123	-124.0/0.000	PASS

SCALE 1.0 CLEAR MSG SPY MESSAGE CLEAR SAVE View SPY MSG (Max. 300 Lines) [TEST TIME] Begin : Finish :

DUT PORT Control DUT while test RXGAIN LOW

a. Pre-Certification Report Window

b. Performance Report Window

Fig 1.16 Report function window

## II. Menu

This chapter explains how to handle a project, DUT, test condition and test environment. With the project menus, users can create, open a project file, delete currently opened project, and create or delete DUT file. Users can also open the ready-made demo project.

- 2.1 PROJECT
- 2.2 SETUP
- 2.3 UTILITY
- 2.4 ABOUT

## 2.1 PROJECT

### 2.1.1 Project Menu

With the project menus, users can create a new project file, open an existing project file, or delete currently opened project. Users can also open the ready-made demo project. The [PROJECT] menu consists of three sub-menus: [New Project], [Open Project] and [Del Current Project].

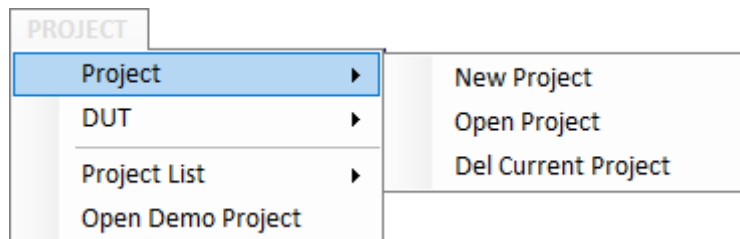

Fig 2.1 Project Menu

#### 2.1.1.1 New Project

To start any test, at least two basic works must be done; one is creating a project and the other is creating a DUT. When you create a new project, 'project\_name.ini' file and the same named directory will be created. A project must have at least one DUT. A project may have many DUTs. When a project is created, the project name and directory information will be displayed in the project information windows.

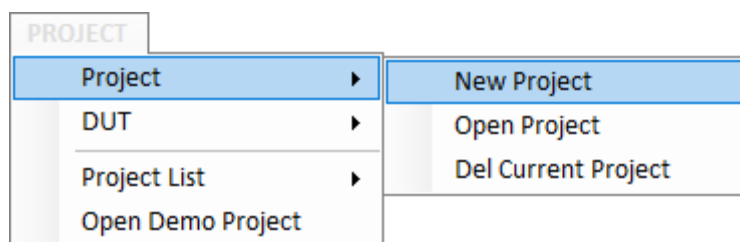

Fig 2.2 Project Menu

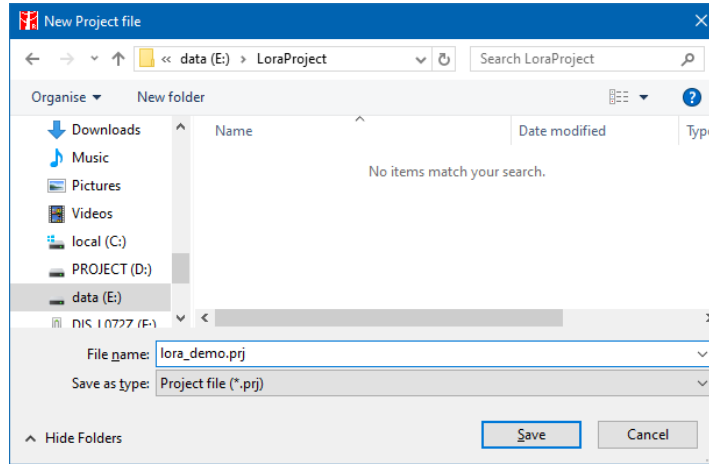

Fig 2.3 Creating a project window



Fig 2.4 Example of a new project (DUT empty)

#### 2.1.1.2 Opening Project

Using [Open project] menu, you can open an existing project file. When a project is opened, the last tested DUT file will be also opened automatically.

#### 2.1.1.3 Deleting Current Project

Using [Del Current Project] menu, you can delete currently opened project including all DUT files in project folder. All deleted projects or DUT files cannot be recovered. Be careful when deleting projects or DUTs.

#### 2.1.1.4 Project List

Project List menu shows the list of projects in current directory. Just clicking one of the listed projects will open the project. Maximum of 7 project names will be saved.

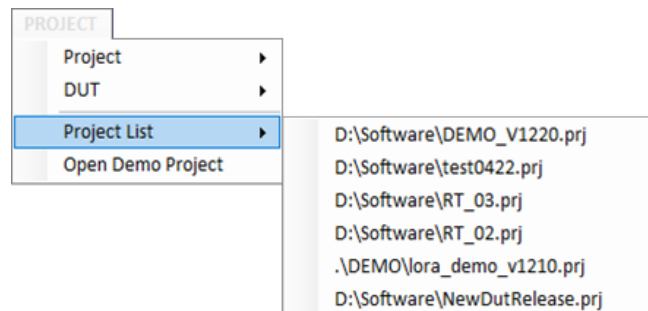

Fig 2.5 Project List Menu

### 2.1.1.5 Opening Demo Project

[Open Demo Project] opens the ready-made demo project.

The demo project is installed with the installation of RWC5020x application in ‘\DEMO\’, the sub-directory of the application installation directory.

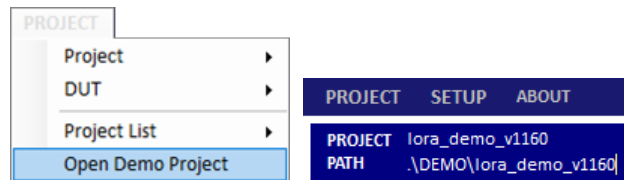

Fig 2.6 [Open Demo Project] menu and directory information

## 2.1.2 DUT menu

In this application, DUT means ‘device name to be tested’. DUT is a member of a project. Before creating a new DUT, you must create a project first. If you created or opened a project, you can create a new DUT and you can create as many DUTs you need. When a new DUT is created, a ‘DUT\_name.ini’ file and the same named directory will be created. If you want to test another DUT, you have to create a new DUT file and test.

### 2.1.2.1 New DUT

When you click [New DUT] in DUT Menu or NEW button, the ‘NEW DUT CREATION’ window will pop up, which is designed to help you create a new DUT. Type a DUT name, select one of DUT types, select one of regions, and click [CREATE] button.

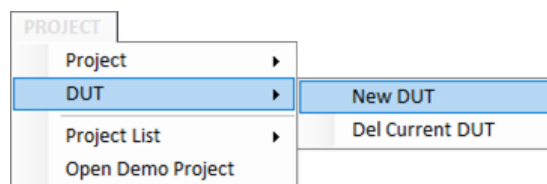

Fig 2.7 New DUT Menu

You have to select DUT parameters such as DUT type, region, LoRaWAN® version, Class, Operator(KR, CN), channel mode(AS), channel plan(CN) and Frequency offset(AS region) shown in the figure 2.8 before you create a DUT file. Once created, you cannot modify the name of the DUT, and the parameters mentioned above. If you want to modify any of them, you must create new one. The AUTO NAMING will help you quickly name it.



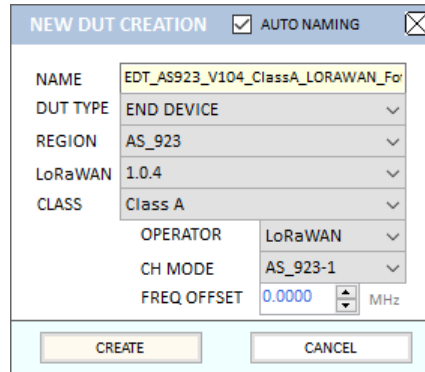

Fig 2.8 Creating a new DUT

The list of DUT names that you created will be shown in DUT list box as shown in the following figure.

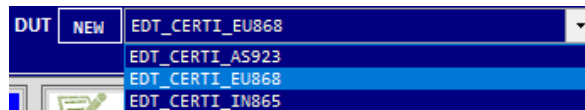

Fig 2.9 List of DUT names

#### 2.1.2.2 DEL Current DUT

Using [DEL Current DUT], you can delete currently opened DUT file. Be careful when deleting DUTs because the deleted DUT file cannot be recovered. You can delete only the currently opened DUT to prevent any unwanted deletion.

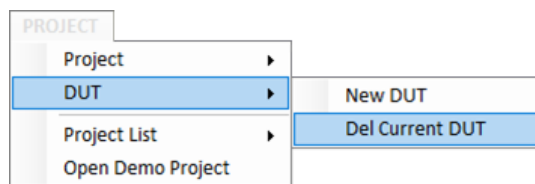

Fig 2.10 Del Current DUT menu

## 2.2 SETUP

### 2.2.1 Connect RWC5020x

RWC5020x Application works under Ethernet connection between users' PC and RWC5020x.

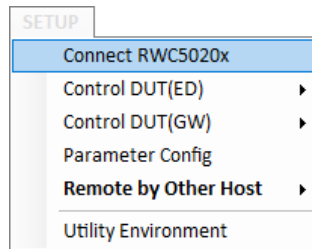



Fig 2.11 Connect RWC5020x menu

#### 2.2.1.1 Open RWC5020x CONTROL PORT window

Clicking on [Connect RWC5020x] in SETUP Menu or clicking on  icon will show the 'RWC5020x CONTROL PORT' window which is designed to help you set up RWC5020x's IP.

#### 2.2.1.2 Setup IP

Set the IP address same as the RWC5020x's IP address connected to the PC and click [CONNECT] button. If your PC recognizes an RWC5020x, the status [CONNECT] will be changed to [CONNECTED].

After connection, the application's title bar will show the version, equipment types (RWC5020A/B/M), and local PC's network IP. Some of the functionality or parameters will be limited according to the type of RWC5020x.

The PC's IP information is useful to set up the server information when you test Gateway's Non-regression performance.

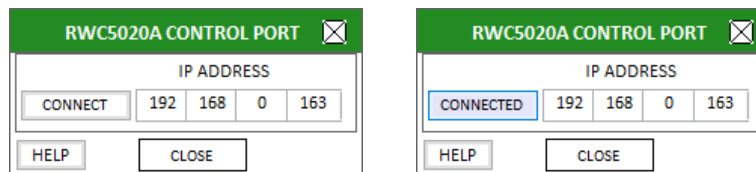

a. Before connected

b. After connected

Fig 2.12 IP setup for connection

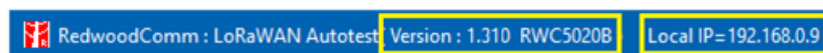

Fig 2.13 The type of RWC5020x and PC's IP address

## 2.2.2 Control DUT(ED)

This function is used to control DUT via RS232 while testing as needed.

Control DUT menu consists of five sub menus: Open Port, Load User Cmds, Show User Cmds, Pop DUT Monitor, and Make Cmds Template. This function will be enabled in SKT certification test.

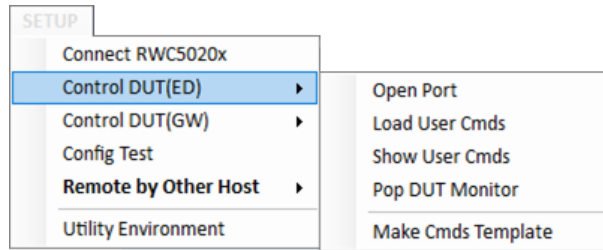
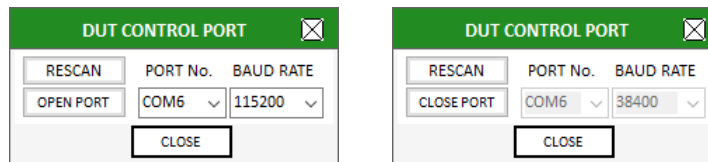

Fig 2.14 Control DUT Menu

### 2.2.2.1 Open PORT

Clicking [Open PORT] will show a 'DUT CONTROL PORT' window that is designed to help set and open UART port for DUT control. After configuring its port number and baud rate, click [OPEN PORT] button within DUT Control Port window. If there is a valid RS232 port, [OPEN PORT] text will be changed to [CLOSE PORT] and 'PORT No.' and 'BAUD RATE' combo boxes will be disabled. If there are no items in 'PORT No.' combo box, click on [RESCAN] button.



a. Before opening port

b. After opening port

Fig 2.15 DUT Control Port Setup

### 2.2.2.2 Load User Commands

Clicking [Load User Cmds] will show 'Open File Window' for opening a DUT control file (.txt) which describes configuration and user commands. If you want to create your own command file, use [Make Cmds Template] function which helps you create a template file.

### 2.2.2.3 Show User Commands

Clicking [Show User Cmds] will show the 'USER COMMAND MAPPER' window and show user-defined commands which are loaded in 2.2.2.2. If you don't have any user command file, click on [TEMPLATE] button to open a template and create your own command file.

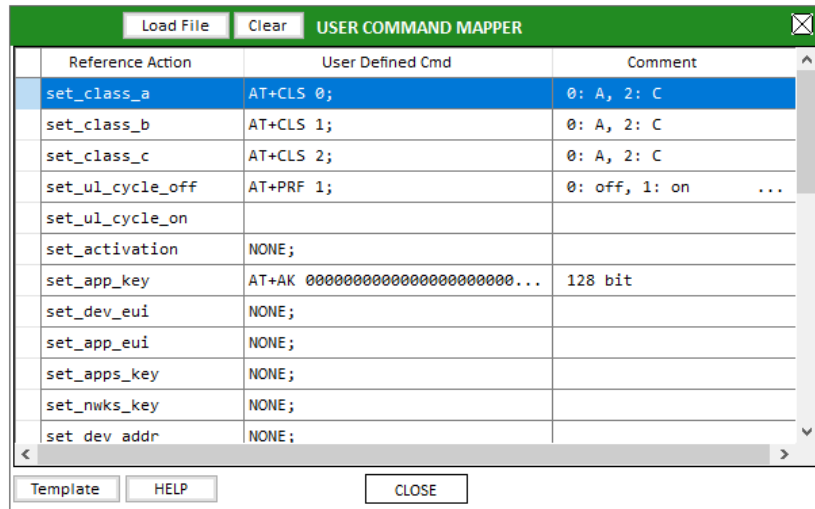

Fig 2.16 Example of USER COMMAND MAPPER

#### 2.2.2.4 Show DUT Monitor

Clicking [Show DUT Monitor] will show a pop-up window to show the commands and DUT’s responses.

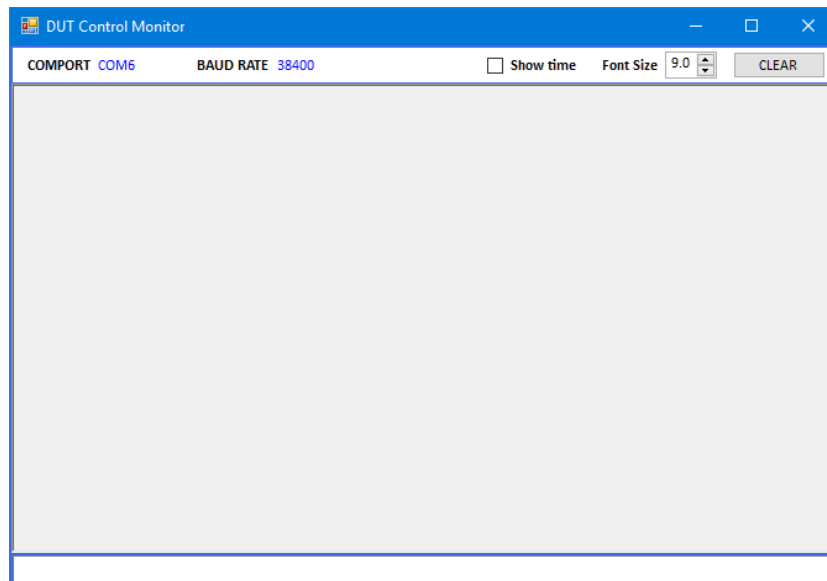

Fig 2.17 DUT Monitor screen

#### 2.2.2.5 Make Commands Template

Clicking [Make Cmds Template] will create a template file that is designed to help create users’ own control commands file. You can fill it up and save it as a text file (.txt) and load it onto ‘USER COMMAND MAPPER’ using [Load User Cmds] menu.

```

USER_CTRL_CMD_TEMPLATE.INI - Notepad
File Edit Format View Help
[CONFIG]
VENDOR=NONAME
NUM_CMDS=34
BAUDRATE=115200
EOL=rn
SEQ_CMD_INTV=1.5
[CMDS]
set_class_a=NONE; //insert your command and parameter
set_class_b=NONE;
set_class_c=NONE;
set_ul_cycle_off=NONE;
set_ul_cycle_on=NONE;
set_activation=NONE;
set_app_key=NONE;
set_dev_eui=NONE;
set_app_eui=NONE;
set_apps_key=NONE;
set_nwks_key=NONE;
set_dev_addr=NONE;
reset_device=NONE;
do_pseudo_join=NONE;
set_adr_en=NONE;
set_adr_dis=NONE;
set_dr0=NONE;
set_dr1=NONE;
set_dr2=NONE;
set_dr3=NONE;
set_dr4=NONE;
set_dr5=NONE;
set_rtr_num=NONE;
send_data_cfm=NONE;
send_data_usefn=NONE;

```

Fig 2.18 Template file to help to create a your command file

### 2.2.3 Control DUT(GW)

This application provides a simple server function for Gateway’s non-regression test defined by SEMTECH. In order to communicate with DUT(Gateway) in JSON, users have to set the gateway’s IP and server’s port number. [Control DUT(GW)/Config IP] menu or [GW IP] button on NON-REGRESS tab of PERFORMANCE function tap shows ‘GW IP/HOST PORT’ window which will help you set the gateway’s IP and the HOST(Server)’s port number.

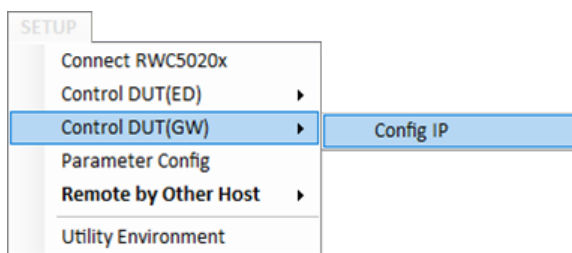

Fig 2.19 [Control DUT(GW)/Config IP] menu

SET GW IP / HOST PORT	
GATEWAY IP	192.168.0.59
SERVER PORT	1780
SERVER IP : 10.0.0.228	

Fig 2.20 [GW IP/HOST PORT] menu

You can find the SERVER IP that is the IP of your PC at the bottom of the setup window.

If all parameters are set up correctly, RWC5020x application will start to wait for gateways messages. After receiving a JSON packet, this application will respond to gateway as a server.

You can find the detail test concept and procedure in chap 3.2.3

## 2.2.4 Parameter Configuration

[Parameter Config] or  shows a window in which users can set up the basic properties of DUT. This configuration is applied to all test functions of the application.

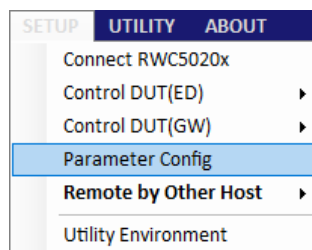

Fig 2.21 Parameter Config menu for displaying 'Parameter configuration' window

When you open parameter configuration window without connection with the RWC5020x, a warning message box will appear to remind that all changed parameter will be adopted only after connection.

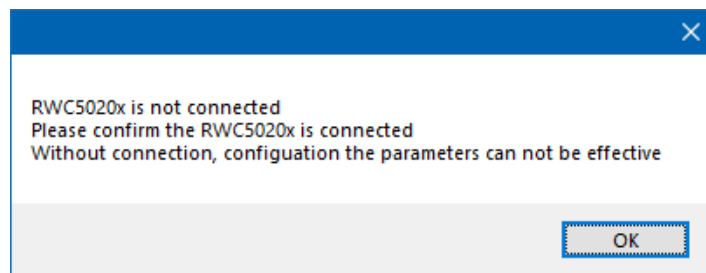

Fig. 2.22 Warning no connection

**PARAMETER CONFIGURATION** All parameters are going to be applied when a test starts

---

DUT TYPE	REGION	PROT-OP	VERSION	CLASS	ACTIVATION
END DEVICE TEST	EU_868	LoRaWAN	1.0.4	Class A	OTAA

---

**PROTOCOL PARAMETERS**

ACTIVATION PARAM  Check EUI

APP\_KEY 0x 00000000000000000000000000000001 32 digits

DEV\_EUI 0x 0000000000000001 16 digits

APP\_EUI 0x 0000000000000001 16 digits

DEV\_ADDR 0x 00000001 8 digits

APPS 0x 00000000000000000000000000000001 32 digits

NWKS 0x 00000000000000000000000000000001 32 digits

**LINK**

NETWORK	PUBLIC
PERIODIC DOWNLINK	NONE
ADR	ON
MAC RSP FIELD	PAYLOAD
MAC RSP SLOT	RX1
DOWNLINK SLOT	RX1

**RF PARAMETERS**

**RF PARAM**

TX POW	-30.0	dBm
RX GAIN	LOW	Range Over-15dBm
RX GAIN WARNING TO	60	min
PATHLOSS	0.0	dB
FREQ OFFSET	0.0	ppm
TIME OFFSET	0	us

**CHANNEL GROUP & MASK**

CH MASK 0x 7

**CHANNEL INFO.**

UpLink Channel List		DownLink Channel List	
UL_CH_00	868.1000	DL_CH_00	868.1000
UL_CH_01	868.3000	DL_CH_01	868.3000
UL_CH_02	868.5000	DL_CH_02	868.5000
UL_CH_03	867.1000	DL_CH_03	867.1000
UL_CH_04	867.3000	DL_CH_04	867.3000
UL_CH_05	867.5000	DL_CH_05	867.5000

DEFAULT
OK
CANCEL

Fig 2.23 PARAMETER CONFIGURATION

#### 2.2.4.1 Protocol Parameters

All parameters are defined in LoRaWAN® Alliance’s specification. Some of the parameters will be changed according to the DUT type, region, LoRaWAN® version, activation method, and class.

#### **DUT TYPE**

There are two types of DUT, END DEVICE and GATEWAY. If the DUT type is END DEVICE, RWC5020x operates as a gateway. If the DUT type is GATEWAY, it operates as an end device.

#### **REGION**

RWC5020x supports various regions [EU 868, EU 433, US 915, AU 915, CN 470, KR 920, AS 923, IN 865, RU 864, KZ 865, IL 917]. Using this parameter, users could select the region to test.

#### **OPERATOR**

This parameter determines whether to enable LoRa operator-specific procedures and parameters. It is only applicable to South Korea (SKT) and China (ICA, CLAA) in the current version of firmware.

#### **PROTOCOL\_VER**

This parameter defines the version of LoRaWAN® protocol to be emulated by RWC5020x.

Supporting versions: 1.0.2 / 1.0.3 / 1.0.4 / 1.1

### **CLASS**

There are three different classes in LoRa device. Class A is Bi-directional End Devices, Class B is Bi-directional End Devices with scheduled receive slots, and Class C is Bi-directional End Devices with maximal receive slots. This parameter defines the class mode of RWC5020x.

### **ACTIVATION**

LoRaWAN® defines two types of Activation procedures (OTAA, ABP). This parameter defines the activation mode of RWC5020x.

### **APP\_KEY**

The APP\_KEY is an AES-128 root key specific to the End Device. Whenever an End Device joins a network via over-the-air activation, the APP\_KEY is used to derive the session keys NwkSKey and AppSKey specific for that End Device to encrypt and verify network communication and application data. This parameter must be set to the same value as the APP\_KEY on DUT.

### **CHECK\_EUI**

This parameter decides whether or not to compare DEV\_EUI and APP\_EUI during activation. If this parameter is checked, RWC5020x (Gateway/Server) compares DEV\_EUI and APP\_EUI and accepts only if the value is equal to the same.

### **DEV\_EUI**

The DEV\_EUI is a globally unique End Device identifier. The DEV\_EUI is stored in the End Device before the activation procedure is executed. If the CHECK\_EUI is ON, this parameter must be set as the same value stored on the DUT.

### **APP\_EUI**

The APP\_EUI is a global application ID in IEEE EUI64 address space that uniquely identifies the entity able to process the Join-request frame. The APP\_EUI is stored in the End Device before the activation procedure is executed. If the CHECK\_EUI is ON, this parameter must be set as the same value stored on the DUT.



### **DEV\_ADDR**

During the activation, the gateway assigns DEV\_ADDR value to the End Device. If activation mode is ABP, this parameter must be set as the same value stored on the DUT. If activation mode is OTAA, this parameter value is used to generate Join-accept message.

### **APPS\_KEY**

APPS\_KEY is used to encrypt and verify application data between Gateway and End Device. This value is derived from APP\_KEY during OTAA. If activation mode is ABP, this parameter must be set as the same value stored on the DUT.

### **NWKS\_KEY**

NWKS\_KEY is used to encrypt and verify network data between Gateway and End Device. This value is derived from APP\_KEY during OTAA. If activation mode is ABP, this parameter must be set as the same value stored on the DUT.

### **UPDATE\_FCNT**

This parameter determines the initial value of FCNT before activation procedure and also updates FCNT values after activation.

### **ADR**

LoRa network allows the End Devices to individually use any of the possible data rates. This feature is used by the LoRaWAN® to adapt and optimize the data rate of static End Devices. This is referred to as Adaptive Data Rate (ADR) and when this is enabled the network will be optimized to use the fastest data rate possible.

### **DOWNLINK\_SLOT**

When RWC5020x emulates Gateway/Server mode (EDT), it could respond to the uplink frame by downlink frame using RX1 window or RX2 window. Using this parameter, users can select RX window for testing the DUT.

### **NET\_ID**

The NET\_ID is a network identifier to uniquely identify the network. This parameter value is used to

generate Join-accept message.

#### **RX1\_DR\_OFFSET**

This parameter sets the offset between the uplink data rate and the downlink data rate used to communicate with the End Device on the first reception slot (RX1). This parameter value is used to generate Join-accept message.

#### **RX2\_DR**

This parameter defines the data rate of a downlink using the second receive window. This parameter value is used to generate Join-accept message.

#### **RECEIVE\_DELAY**

The first receive window RX1 opens RECEIVE\_DELAY seconds after the end of the uplink modulation. This parameter value is used to generate Join-accept message.

#### **LINK\_MARGIN**

This parameter is an 8-bit unsigned integer in the range of 0~254 indicating the link margin in dB of the last successfully received *LinkCheckReq* command. This parameter value is used to generate *LinkCheckAns* command.

#### **GATEWAY\_CNT**

This parameter is the number of gateways that successfully received the last *LinkCheckReq*. This parameter value is used to generate *LinkCheckAns* command.

#### **YEAR**

This parameter indicates the year of RWC5020x time information. This parameter is used to generate *DeviceTimeAns* command and Beacon.

#### **MONTH**

This parameter indicates the month of RWC5020x time information. This parameter is used to generate *DeviceTimeAns* command and Beacon.

### **DAY**

This parameter indicates the day of RWC5020x time information. This parameter is used to generate *DeviceTimeAns* command and Beacon.

### **HOUR**

This parameter indicates the hour of RWC5020x time information. This parameter is used to generate *DeviceTimeAns* command and Beacon.

### **MINUTE**

This parameter indicates the minute of RWC5020x time information. This parameter is used to generate *DeviceTimeAns* command and Beacon.

### **SECOND**

This parameter indicates the second of RWC5020x time information. This parameter is used to generate *DeviceTimeAns* command and Beacon.

### **NETWORK**

This parameter indicates the type of LoRa network, in other words the synchronization word to be used in LoRa modulation.

#### 2.2.4.2 RF Parameters

RF parameters are related with RWC5020x's hardware, test environment, and control parameters.

### **TX\_POW**

This parameter defines the output power of RWC5020x in dBm.

### **INIT\_RX\_GAIN**

The RWC5020x has an AGC (Automatic Gain Control) function. So the RWC5020x will set appropriate RX gain after receiving a few packets from the DUT. This parameter defines the initial RX gain when the Link is started. It is very important to set this parameter correctly to get the proper test result quickly. Set to LOW

if the expected input level from your DUT to RWC5020x is higher than -15dBm. Set to HIGH if the expected input level is lower than -40dBm. Otherwise set it to MIDDLE.

#### **PATH\_LOSS**

Users can set the path loss between RF port of RWC5020x and DUT RF port. RWC5020x's real output power will be increased by this value to compensate path loss.

#### **SYSCLK\_OFFSET**

This parameter defines the system clock frequency (32MHz) offset value in ppm. It modifies RF frequency as well as LoRa modulation signal.

#### **FREQ\_OFFSET**

This parameter defines the RF frequency offset value in ppm.

#### **TIME\_OFFSET**

This parameter defines the time offset value in us.

#### **CH\_MASK\_0**

This parameter defines the mask of channels to be used for LoRa communication, which is applicable only to regions of EU 868, EU 433, KR 920, AS 923, IN 865, RU 865, and KZ 865.

#### **CH\_GROUP**

This parameter defines the mask of the channels to be used for LoRa communication, which is applicable only to regions of US 915, AU 915, and CN 470.

#### **RX2\_FREQ**

This parameter defines the frequency of a downlink using the second receive window.

#### **RX2\_DR**

This parameter defines the data rate of a downlink using the second receive window.

#### **DL\_CH\_00 ~ DL\_CH\_07**

This parameter defines real channel frequency of each downlink channel index.

**UL CH 00 ~ UL CH 07**

This parameter defines real channel frequency of each uplink channel index.

**UL CH 64 ~ UL CH 71**

This parameter defines real channel frequency of each 500kHz uplink channel index.

**2.2.5 Remote by Other host**

This application provides a way to control itself by other controller via RS232. This function is a quite limited way to control but is useful to test pre-certification remotely. For more detail, refer the application note.

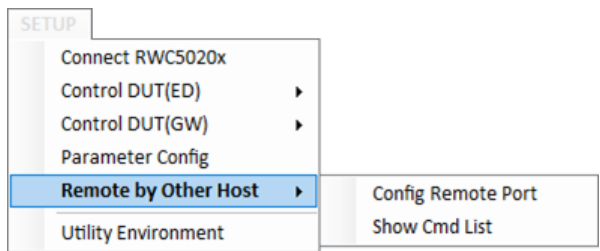

Fig 2.24 [Config Remote Port] menu

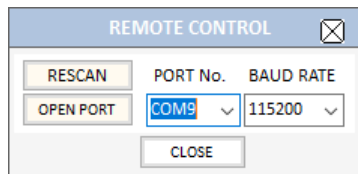

Fig 2.25 REMOTE COTROL setup window

To see the remote commands, click on the [Show Cmd List] menu.

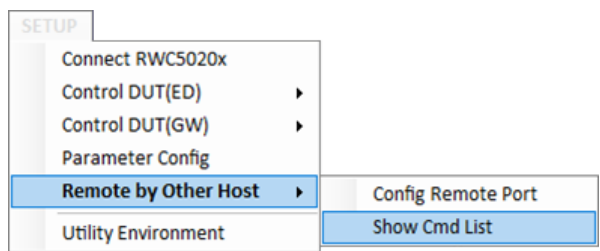

Fig 2.26 [Show Comd List] menu

REMOTE COMMANDS LIST	
PC:CONF:MODE [PARAM]	PARAM=CERT/PERF/UTIL/LINK
PC:CONF:CERT:EU_CERT [PARAM]	PARAM=SEL_ALL/DESEL_ALL
PC:CONF:CERT:US_CERT [PARAM]	PARAM=SEL_ALL/DESEL_ALL
PC:CONF:CERT:AS_CERT [PARAM]	PARAM=SEL_ALL/DESEL_ALL
PC:CONF:CERT:KR_CERT [PARAM]	PARAM=SEL_ALL/DESEL_ALL
PC:CONF:CERT:IN_CERT [PARAM]	PARAM=SEL_ALL/DESEL_ALL
PC:CONF:CERT:REGION [PARAM]	PARAM=EU/US/AS/KR/IN
PC:READ:IDN?	
PC:READ:RWC5020X_SERIAL?	
PC:READ:COMMANDS?	
PC:READ:CERT_STAT?	
PC:READ:CERT_CURR?	
PC:EXEC:CREATE_DUT [PARAM]	PARAM=DUT_NAME(just)
PC:EXEC:OPEN_DUT [PARAM]	PARAM=DUT_NAME(just)
PC:EXEC:CREATE_PRJ [PARAM]	PARAM=PRJ_NAME(should be full path including drive name)
PC:EXEC:CERT START	
PC:EXEC:CERT STOP	
PC:EXEC:CON_RWC5020 [PARAM]	PARAM=123.123.123.123

Fig 2.27 Remote commands list for controlling PC application program

## 2.2.6 Utility Environment

This function is for user convenience. All options are saved and reloaded automatically

### DUT CONTROL ENVIRONMENT

- Load commands at start

This application remembers the last user command file name. If you check this option, it will load the last user command files when the application is started.

- Open port at start

This application remembers the last opened RS232 port name. If you check this option, it will reconnect the last opened RS232 port when started. But be careful when using this option, because it could take longer to launch the application if there is no same port anymore.

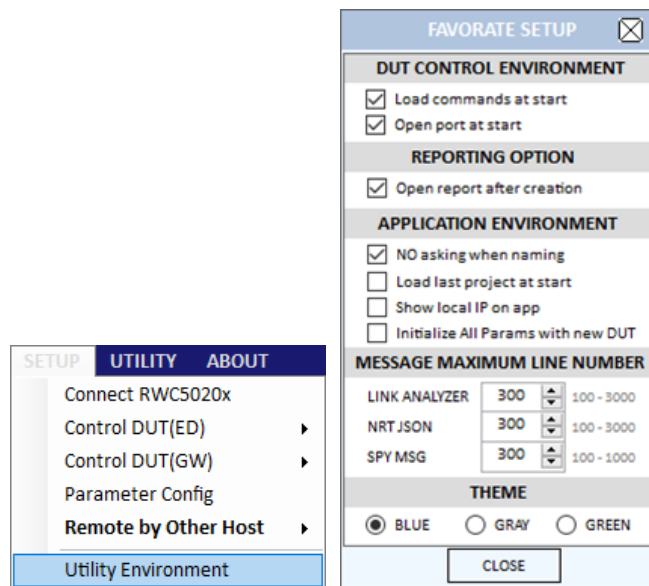

Fig 2.28 [Utility Environment] menu

### **REPORTONG OPTION**

- Open report after creation

If you check this option, the application will open the created report automatically when you create a report file. If not checked, the report will be created but not opened automatically.

### **APPLICATION ENVIRONMENT**

- NO asking when naming

If you check this option, the application will create or save files without opening a file wizard window.

- Load last project at start

If you check this option, the application will open the last opened project when it starts.

- Show local IP on app.

If you check this option, the application will show your PC's IP address on the top.

- Initialize All Parameters with new DUT.

If you check this option, this application will initialize all test parameters as default without asking. If not checked, it will use them as it was.

### **MESSAGE MAXIMUM LINE NUMBER**

- LINK ANALYZER

The maximum line number of the log window in the Link analyzer tab.

Range : 100 - 3000

o NRT JSON

The maximum line number of the JSON log window in the non-regression test function tab.

Range : 100 - 3000

o SPY MSG

The maximum line number of the SPY message window

Range : 100 - 1000

**THEME**

o BLUE

This option sets the color theme of the application as blue.

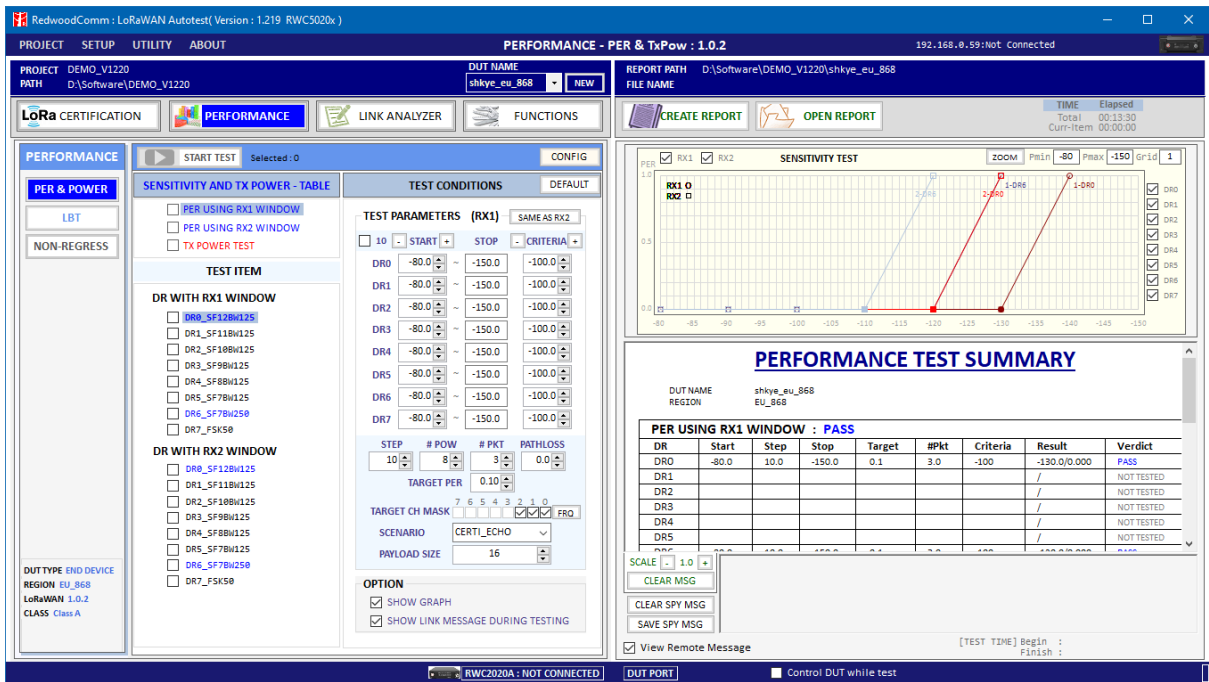

Fig 2.29 Blue theme of RWC5020x application

o GRAY

This option sets the color theme of the application as gray.



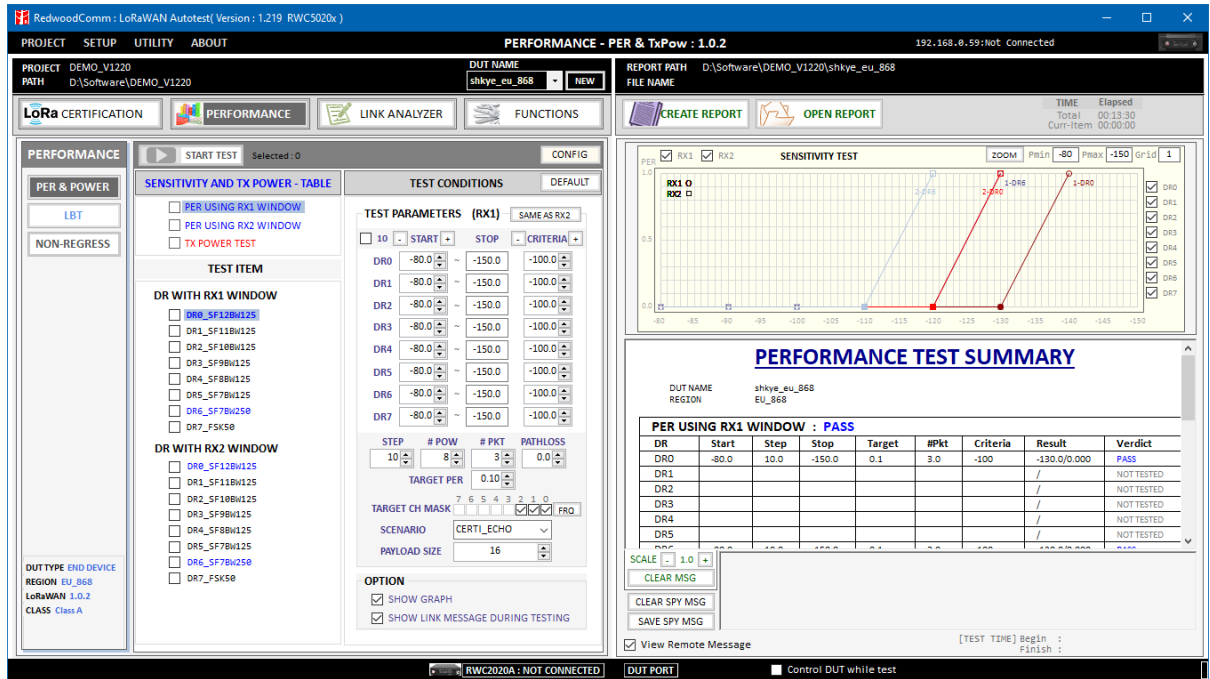

Fig 2.30 Gray theme of RWC5020x application

o GREEN

This option sets the color theme of the application as green.

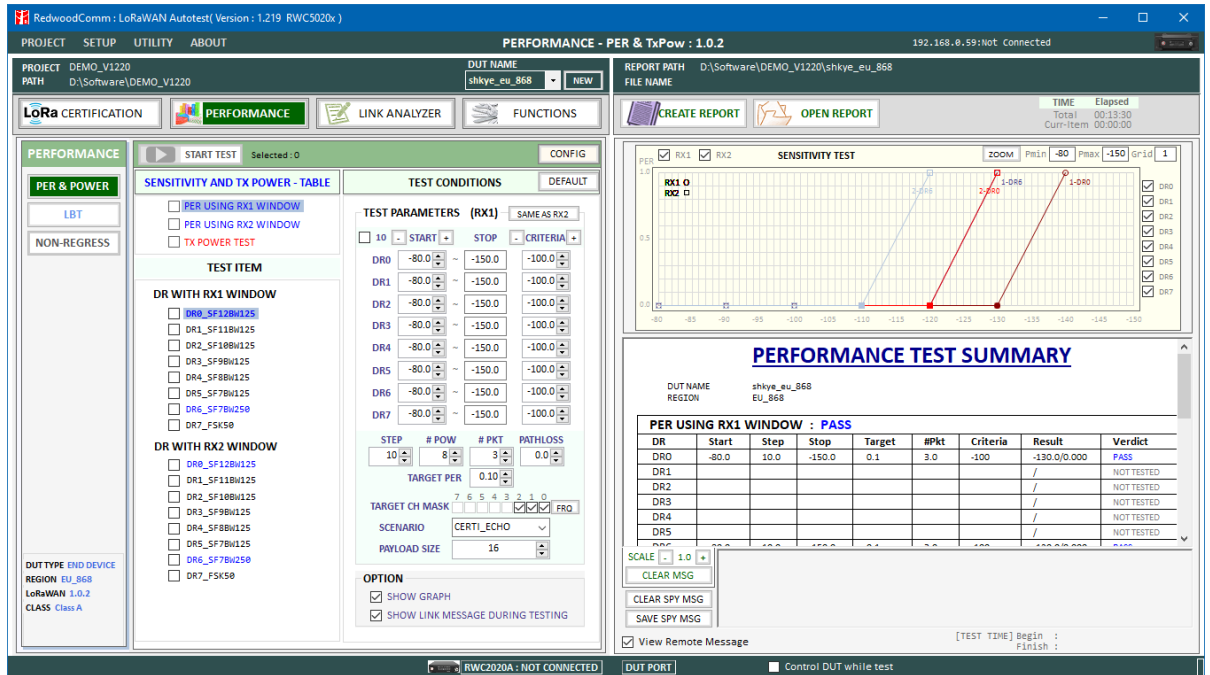

Fig 2.31 Green theme of RWC5020x application

## III. Test Functions

This chapter explains how to use pre-certification tests, RF performance tests, Link Analyzer, other functions and utilities. With test functions, you can select one of tests, handle test operation, and set up test environment.

- 3.1 Pre-Certification Test
- 3.2 Performance Test
- 3.3 Link Analyzer
- 3.4 Functions
- 3.5 Utilities

## 3.1 Pre-Certification Test

This application provides the LoRaWAN® pre-certification test functions. Refer to the fig 3.1 for simple operation of the function.

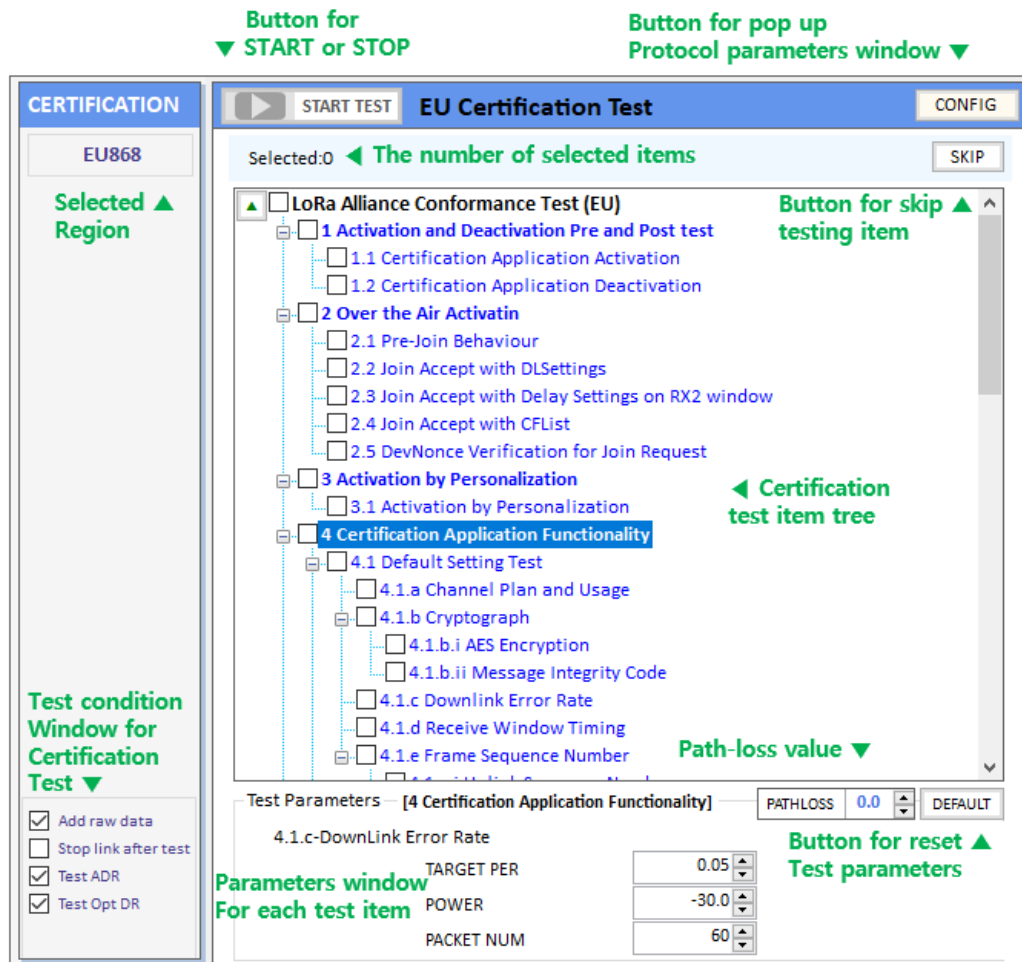
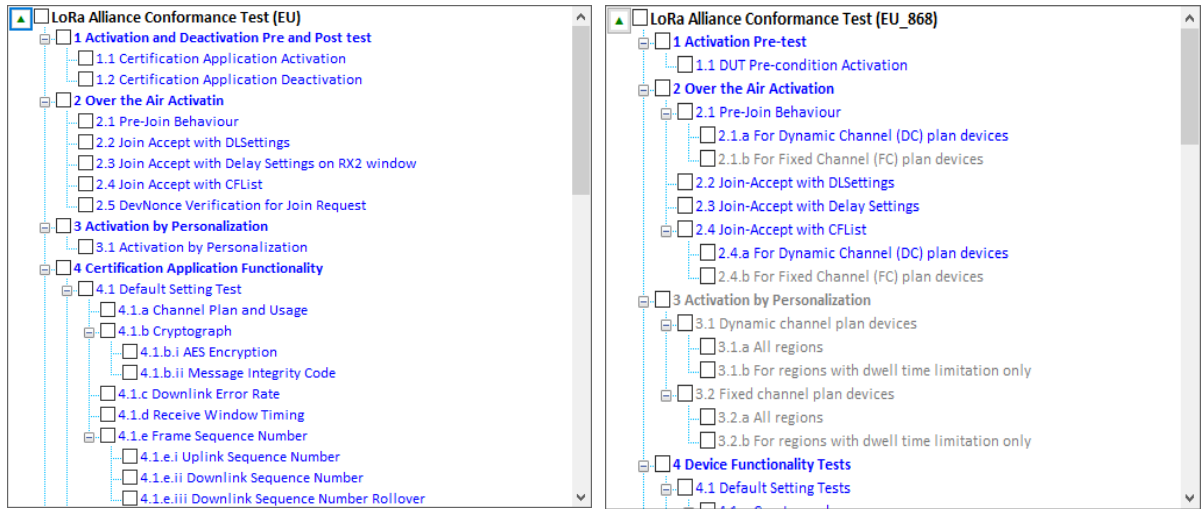

Fig 3.1 Test function window for LoRaWAN® pre-certification.

### 3.1.1 LoRaWAN® Pre-Certification

This application provides a test function which is compatible for LoRaWAN® protocol test. We named it LoRaWAN® Pre-certification. It is available in the version of '1.0.2/1.0.3' and '1.0.4'. For the version '1.0.2/1.0.3' it provides 5 regions such as EU, US/CA, AS, KR, and IN. For the version '1.0.4' it provides 9 regional pre-certification test such as EU868, EU433, US/CA, AS, KR, IN, RU, AU, and IL. Other regional certification functions will be added as soon as they published. If you select region and version of LoRaWAN® when you create a new DUT file, all regional parameters and test items will be configured automatically according to the certification.



a. LoRaWAN® Version 1.0.2/1.0.3

b. LoRaWAN® Version 1.0.4

Fig 3.2 Two different pre-certification test a.to the versions of LoRaWAN® (EU case)

### 3.1.2 Operator Certification

There is an Operator Certification option, SKT. Other private certifications could be added according to further requests.



Fig 3.3 A special operator's certification test (SKT)

### 3.1.3 Pre-Certification Test Items

#### 3.1.3.1 Meaning of Text Colors

Each color has the meaning of verdict; the blue-colored items mean PASSED, the red-colored items mean FAILED, the black-colored items mean NOT\_TESTED, and the grey-colored ones mean Not-selected OPTIONAL items.

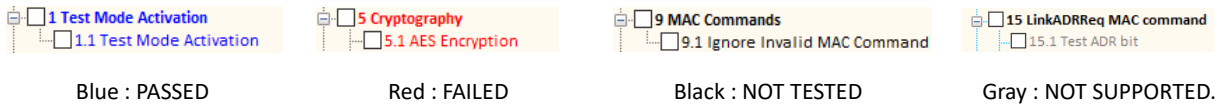

Fig 3.4 Colored text in pre-certification test window

### 3.1.3.2 Selection and Test Parameter Configuration

Select the test items to be tested by clicking the check boxes in front of the subtitles. If you click a test item, its test parameters will be shown at the bottom of test items.

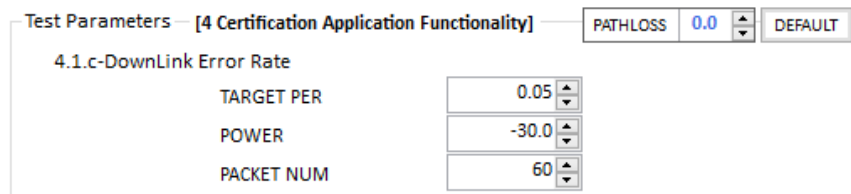

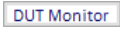

Fig 3.5 Configuration of Test Parameters

### 3.1.3.3 Start Test

If you click  button, all selected items will be tested sequentially. Keep in mind RWC5020x application program will automatically overwrite the result after each item is tested without asking whether selected item was tested previously or not. In other words, the application will always keep the recent test results.

### 3.1.3.4 Control DUT

If you want to control DUT while testing, have the box  **Control DUT** checked. Then this application will send control command according to the loaded user control command file. Refer to 2.2.2 for DUT control. You can see the transmitted commands and received responses to/from DUT respectively on DUT control monitor window. Click the  button and a large DUT control monitor will pop up.

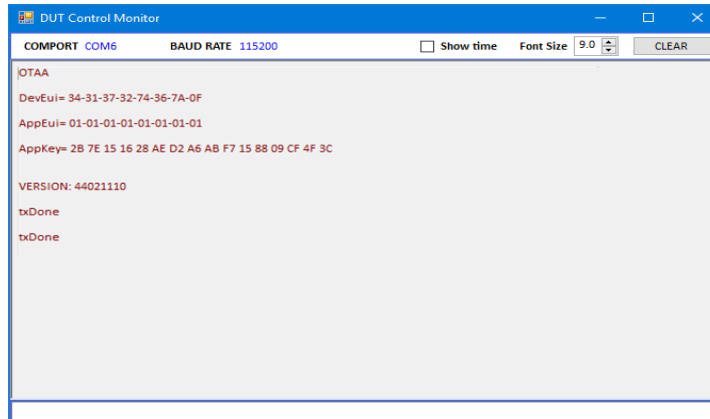
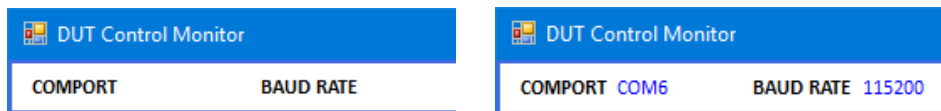

Fig 3.6 DUT Control Monitor

COMPORT and BAUDRATE information of the current control port will be displayed as follows.



a. Before connection

b. After connection

Fig 3.7 COMPORT and BAUDRATE after connection.

### 3.1.3.5 Test Result – Summary Table

If you click on the certification title, you can see the test summary table on result window.

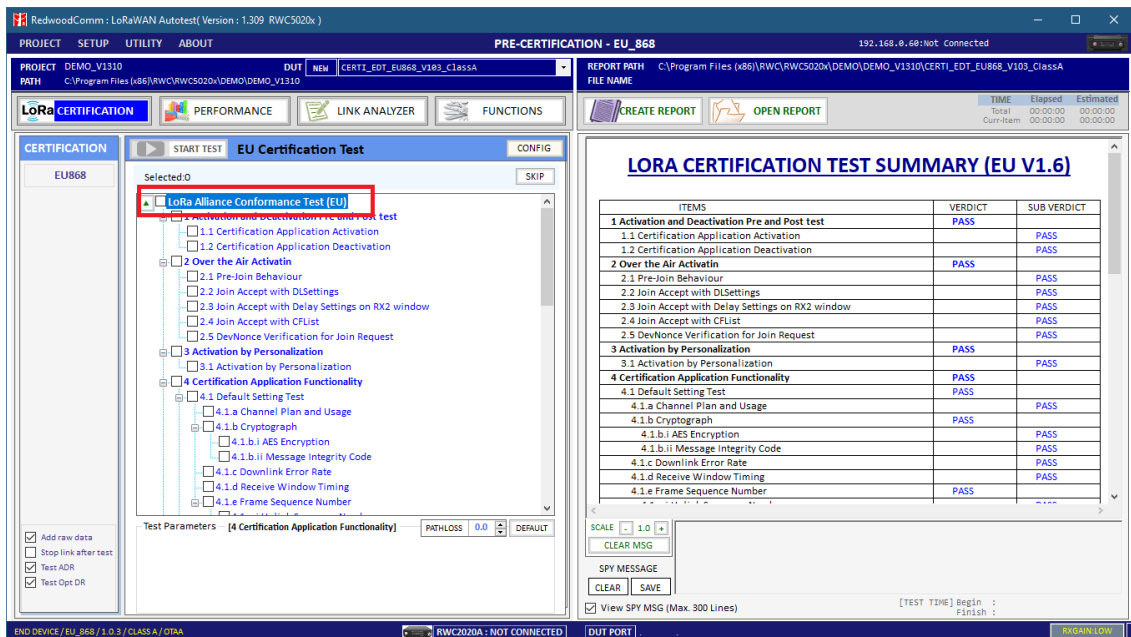

Fig 3.8 Displaying Test Result – Summary Table

### 3.1.3.6 Test Result – Detail Report

If you click on the sub test item title text, you can see the detailed test result on result window

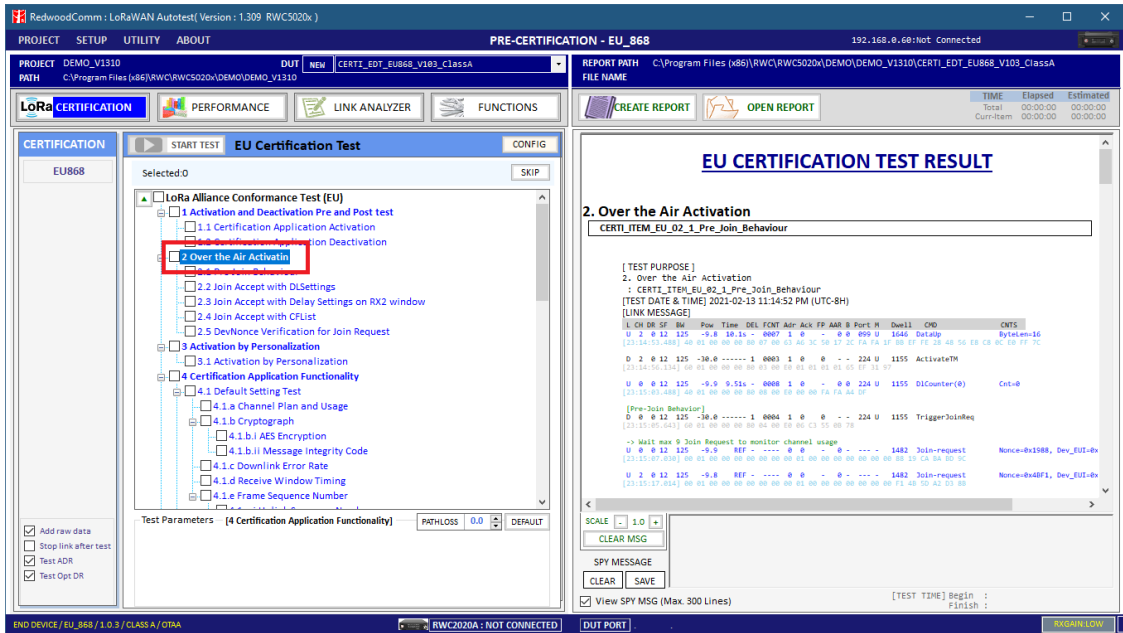
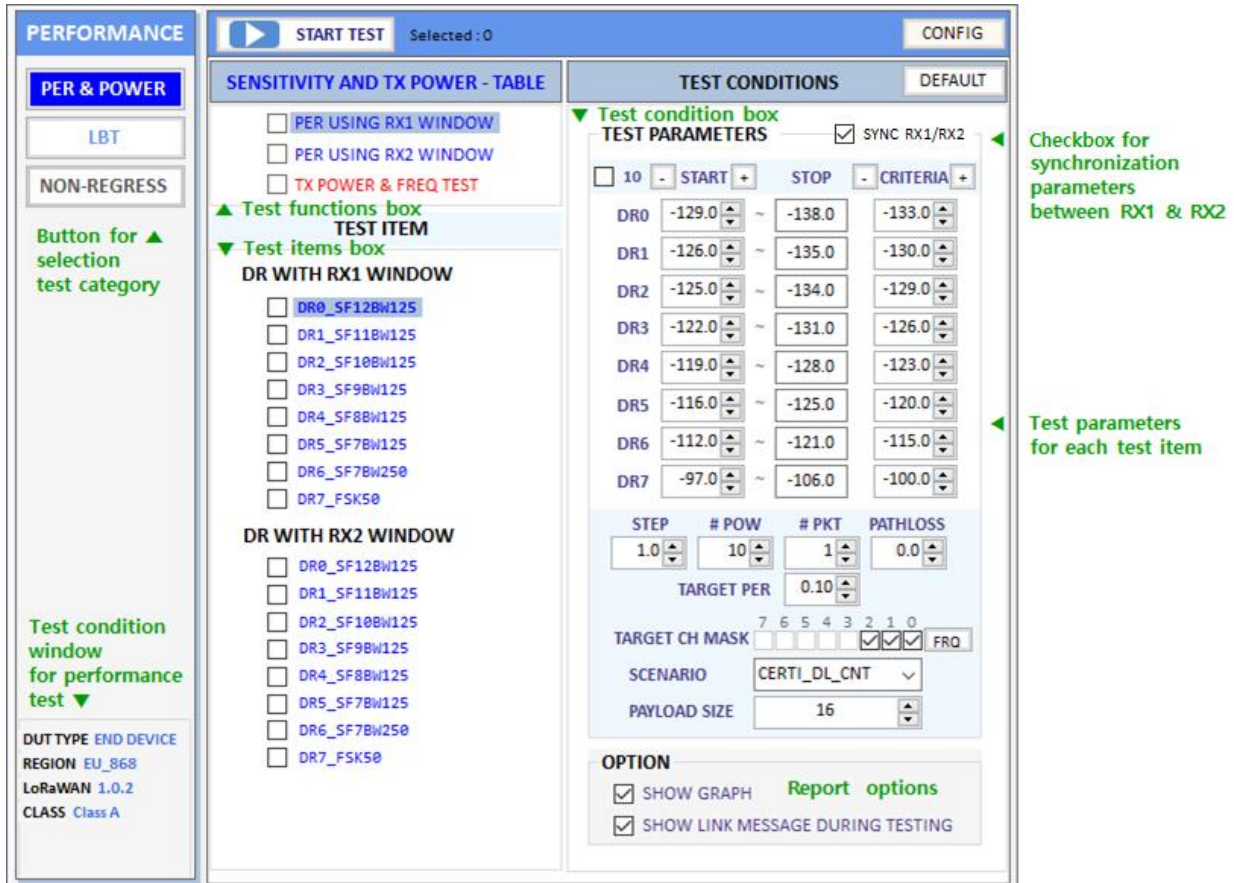

Fig 3.9 Displaying Test Result – Detail Report

## 3.2 Performance Test

Performance test function consists of PER & POWER, LBT, and NON-REGRESS test. Refer to the figure 3.10 for an example.



The screenshot shows the 'PERFORMANCE' test configuration window. On the left, there are three test categories: 'PER & POWER' (selected), 'LBT', and 'NON-REGRESS'. Below these are buttons for selection and a 'Test condition window for performance test'. The main area is divided into 'SENSITIVITY AND TX POWER - TABLE' and 'TEST CONDITIONS'. The 'TEST CONDITIONS' section includes a 'Test condition box' with a 'TEST PARAMETERS' table and various control options.

TEST ITEM	START	STOP	CRITERIA
DR0	-129.0	-138.0	-133.0
DR1	-126.0	-135.0	-130.0
DR2	-125.0	-134.0	-129.0
DR3	-122.0	-131.0	-126.0
DR4	-119.0	-128.0	-123.0
DR5	-116.0	-125.0	-120.0
DR6	-112.0	-121.0	-115.0
DR7	-97.0	-106.0	-100.0

Annotations in the image point to a 'Checkbox for synchronization parameters between RX1 & RX2' (checked) and 'Test parameters for each test item' (the table above).

Fig 3.10 Test parameters and conditions

### 3.2.1 PER & POWER

This function allows RWC5020x to search the sensitivity level by measuring the PER (Packet Error Rate) and measure TX power of DUT according to the test parameters and conditions. You can modify test conditions and parameters. If you click on the [CONFIG] menu, you can set protocol parameters in PARAMETER CONFIGURATION window.

#### 3.2.1.1 Selection item

Select or deselect each item that you want to test by clicking each check box in test items box. If you want to add or remove all test items at once, have the check box of the title checked or unchecked in test function box. Whenever you click on each test item, its test conditions will be shown in test condition box. If you want to change the displayed item, click each test title in test function box.



### 3.2.1.2 Test conditions

All test condition parameters such as start power, power step, number of power, and number of packets can be set up in functions window.

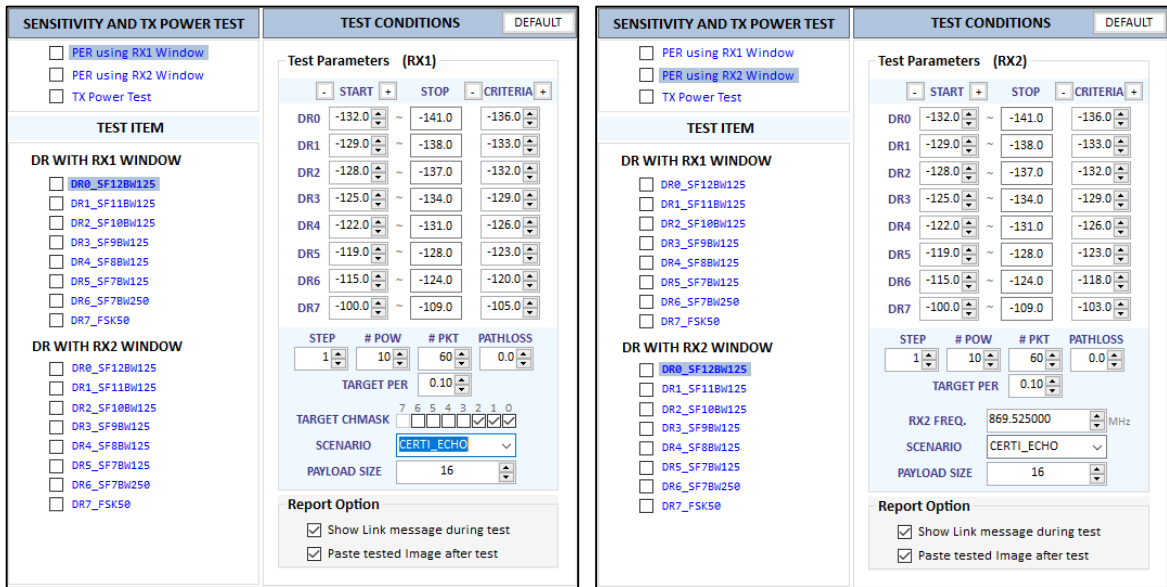

Fig 3.11 Test Conditions for PER using RX1 and RX2 Window

### Parameters for PER test using RX1 and RX2 Window

#### SCENARIO

This is the test scenario of the sensitivity test. In 'NORMAL\_UL', DUT should send unconfirmed or confirmed uplink messages periodically and the Tester sends confirmed downlink messages and checks the flag of acknowledgement in DUT frames in order to count errors. In 'CERTI\_ECHO', DUT should enter the test mode by the Tester's activation command and the Tester will use EchoRequest/EchoResponse in order to count errors. In 'CERTI\_DL\_CNT', DUT should enter the test mode by the Tester's activation command and the Tester will use DL\_Counter value in order to count errors.

For Version 1.0.2/1.0.3, it supports NORMAL\_UL, CERTI\_ECHO, CERTI\_DL\_CNT

For Version 1.0.4, it supports NORMAL\_UL only

#### PACKET\_NUM

This is the packet number of tests at each test point. Increasing it the test result may have higher resolution but the testing time may become longer.

**START POW**

This defines the start value of POWER sweep.

**STOP POW**

This defines the stop value for POWER sweep (read only).

**STEP POW**

This defines the step value for POWER sweep.

**NUM POW**

This defines the number of power values for POWER sweep.

**TARGET PER**

This is a parameter to set user's target PER. The test sweeps fully in the range of POWER until DUT does not satisfy TARGET\_PER.

**TARGET CH MASK**

This parameter encodes the channels usable for uplink access. A bit in the CH\_MASK field set to 1 means that the corresponding channel can be used for uplink transmissions.

**TARGET DL CH 00 ~ 07**

This parameter redefines DL channel frequencies for sensitivity test. Tester will use DL\_CHANNEL\_REQ MAC command to modify downlink channel frequencies.

**DOWNLINK SLOT**

This is a parameter to select RX window of for testing the DUT.

**TARGET DR**

This is a parameter to determine the DR by sending MAC command before before Sensitivity Test starts. *LinkADRReq* will be sent in case of RX1 and *RXParamSetReq* will be sent in case of RX2.

**DL\_PACKET**

This is a parameter to define the contents of downlink packets to be used in 'NORMAL\_UL' scenario.

**FPORT**

This parameter defines the FPort number of a user-defined MAC Command.

**PAYLOAD\_SIZE**

This parameter defines the size of payload of a user-defined MAC Command.

**PAYLOAD**

This parameter defines the content of payload in hexadecimal format.

**Parameters of TX Power Test**

**MODE**

It determines test method of Power Measurement. If it is set at SYNC\_TO\_LINK, Power measurement is fully synchronized with Link Analyzer. Power Measure displays all Received packets while Link Analyzer is running. If it is set as SCENARIO, Power Measure function measures TX power of DUT using special scenarios which is selected by SCENARIO parameter.

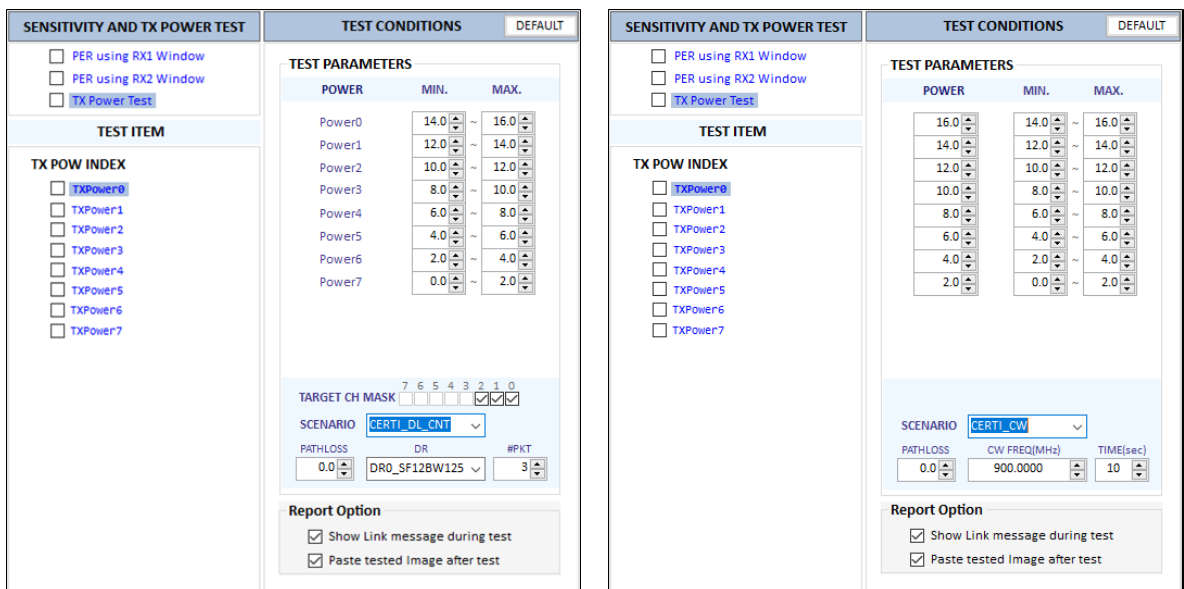

a. Test condition for TX Power test using LoRa Signal

b. Test condition for TX Power test using CW

Fig 3.12 Test Conditions for TX Power Test

### **SCENARIO**

It has three different scenarios to activate DUT to measure power of DUT. NORMAL\_UL scenario mode just receives any packet from DUT and measure the power. CERTI\_DL\_CNT scenario will set the DUT as Test mode at the beginning stage and measure the power of DL\_counter packets from DUT. CERTI\_CW scenario will set the DUT as Test mode and transmit CW\_ENABLE MAC command to transmit CW signal by DUT and measure this CW signal power. If you are using RWC5020B, this scenario mode also measures CW frequency value.

For Version 1.0.2/1.0.3, it supports NORMAL\_UL, CERTI\_DL\_CNT, CERTI\_CW

For Version 1.0.4, it supports NORMAL\_UL, CERTI\_CW

### **UL\_DR**

This parameter is the requested data rate of End Device for uplink message.

### **ADR\_POWER**

This parameter is the requested output power of End Device for uplink message.

### **TARGET\_CH\_MASK**

This parameter encodes the channels usable for uplink access. A bit in the CH\_MASK field set to 1 means that the corresponding channel can be used for uplink transmissions.

### **#PKT**

This parameter defines minimum packet number for power measurement on each channel which is defined by TARGET\_CH\_MASK.

### **CW\_TIMEOUT**

This parameter indicates the timeout for CW transmission.

### **CW\_FREQ**

This parameter indicates the frequency of CW signal.

### **CW\_POW**

This parameter indicates the power of CW signal.

### 3.2.1.3 Protocol Parameters

If you want to modify more details of protocol parameter such as keys, network, channel mask, and so on, click on **CONFIG** button and the parameter configuration window will appear as shown in Fig 3.13.

Listed protocol parameters will be changed according to the functions such as certification, performance, and link analyzer.

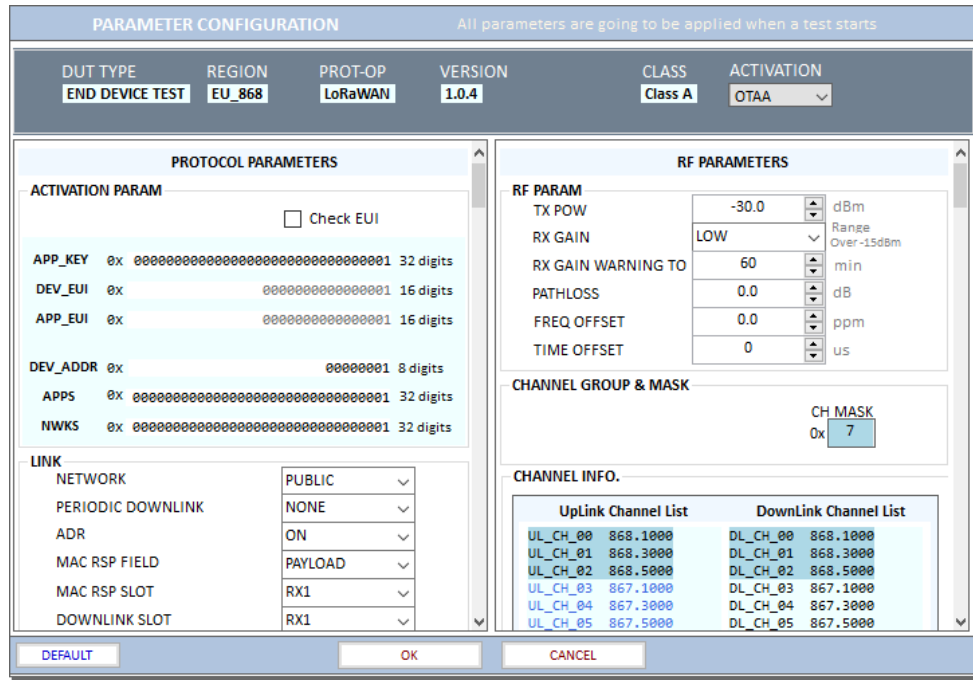

Fig 3.13 Parameter configuration window

### 3.2.1.4 Start/Stop Test

If you click on the **START TEST** button, the selected test items will be tested sequentially. Anytime you can stop the test by clicking same button. It can take a long time to save the tested data. During the test, you can uncheck the selected test items that are still not tested yet. But for tested items, unchecking is not effective.

### 3.2.1.5 Tested Result

If you click on the **SENSITIVITY AND TX POWER - TABLE** title, you can see the test result summary table.

### PERFORMANCE TEST SUMMARY

DUT NAME: ED7\_PERF\_EU868  
REGION: EU\_868

**PER USING RX1 WINDOW : PASS**

DR	Start	Step	Stop	Target	#Pkt	Criteria	Result	Verdict
DR0	-129.0	1.0	-138.0	0.100	1	-133	-135.0/0.000	PASS
DR1	-126.0	1.0	-135.0	0.100	1	-130	-133.0/0.000	PASS
DR2	-125.0	1.0	-134.0	0.100	1	-129	-131.0/0.000	PASS
DR3	-122.0	1.0	-131.0	0.100	1	-126	-128.0/0.000	PASS
DR4	-119.0	1.0	-128.0	0.100	1	-123	-125.0/0.000	PASS
DR5	-116.0	1.0	-125.0	0.100	1	-120	-122.0/0.000	PASS
DR6	-112.0	1.0	-121.0	0.100	1	-115	-120.0/0.000	PASS
DR7	-97.0	1.0	-106.0	0.100	1	-100	-101.0/0.000	PASS

**PER USING RX2 WINDOW : PASS**

DR	Start	Step	Stop	Target	#Pkt	Criteria	Result	Verdict
DR0	-129.0	1.0	-138.0	0.100	1	-133	-136.0/0.000	PASS
DR1	-126.0	1.0	-135.0	0.100	1	-130	-133.0/0.000	PASS
DR2	-125.0	1.0	-134.0	0.100	1	-129	-131.0/0.000	PASS
DR3	-122.0	1.0	-131.0	0.100	1	-126	-127.0/0.000	PASS
DR4	-119.0	1.0	-128.0	0.100	1	-123	-125.0/0.000	PASS
DR5	-116.0	1.0	-125.0	0.100	1	-120	-123.0/0.000	PASS
DR6	-112.0	1.0	-121.0	0.100	1	-115	-119.0/0.000	PASS
DR7	-97.0	1.0	-106.0	0.100	1	-100	-102.0/0.000	PASS

**TX POWER & FREQ TEST : FAIL**

POW	CH0	CH1	CH2	CH3	CH4	CH5	CH6	CH7	Verdict
0	-27.4								FAIL
1	-27.4								FAIL
2	-27.5								FAIL
3	-27.5								FAIL

View Remote Message SCALE 1.0 CLEAR MSG [TEST TIME] Begin : Finish :

Fig 3.14 Test Result – Summary Table

If you click on **PER using RX1 Window** you can see all tested results in detail in the result window from SF12 to SF7

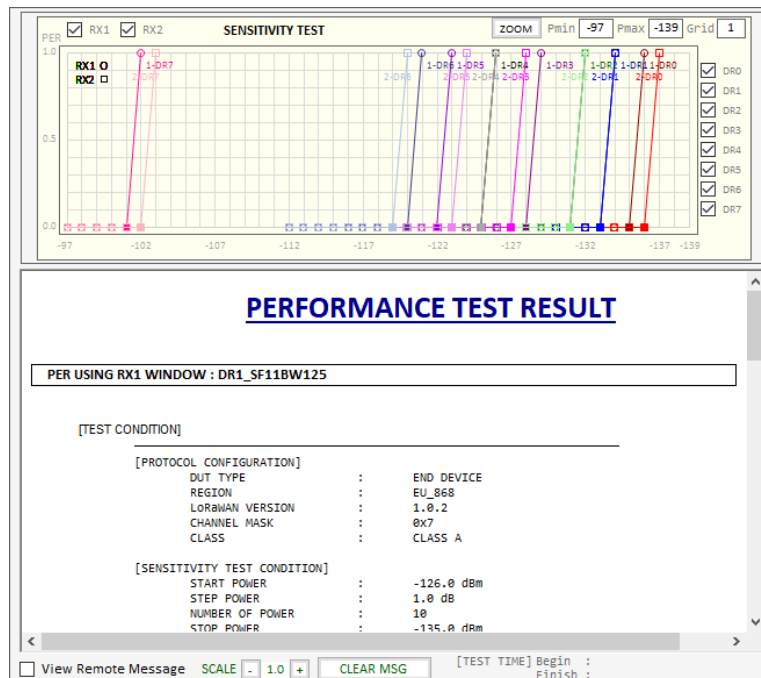

Fig 3.15 Test Result – Detail Report

### 3.2.1.6 PER Performance test functionality condition

#### Synchronization PER test parameters between RX1 and RX2

When you check  SYNC RX1/RX2, test condition parameters such as START, CRITERIA, STEP, #POW, #PKT, TARGET PER of RX1 and RX2 will be same.

#### Test parameter value changing Unit

When you check  10, START and CRITERIA parameters will be changed in 10dB unit when you change these values using arrow buttons. Without checked they will be changed in 1dB unit.

#### Showing link message during test

When you check  SHOW LINK MESSAGE DURING TEST, all link messages will be added in report

[ LINK MESSAGE ]												
L	CH	SF	BW	POW	TIME	FCNT	Adr	Ack	B	FP	M	CMD
U	0	7	125	11.6	REF	----	0	0	---	-	-	Join-request
D	0	7	125	-30.0	----	----	0	0	---	-	-	Join-accept
U	2	12	125	11.8	7.80s	0000	0	0	-	002	U	DataUp
D	2	12	125	-30.0	----	0001	0	0	-	224	U	ActivateTM
U	1	12	125	11.9	8.44s	0001	0	0	-	224	U	DownlinkCounter
D	1	12	125	-30.0	----	0002	0	0	-	000	U	LinkADRReq
U	1	12	125	11.8	5.18s	0002	0	0	-	224	U	LinkADRAns
D	1	12	125	-30.0	----	0003	0	0	-	224	U	EchoRequest
U	0	12	125	11.8	5.35s	0003	0	0	-	224	U	EchoResponse
D	0	12	125	-132.0	----	0004	0	0	-	224	U	EchoRequest
U	2	12	125	11.8	5.02s	0004	0	0	-	224	U	EchoResponse

Fig 3.16 Link Messages attached in Test Report

#### Showing graph

When you check  SHOW GRAPH, it will show PER curve or TX power graph in report function window.

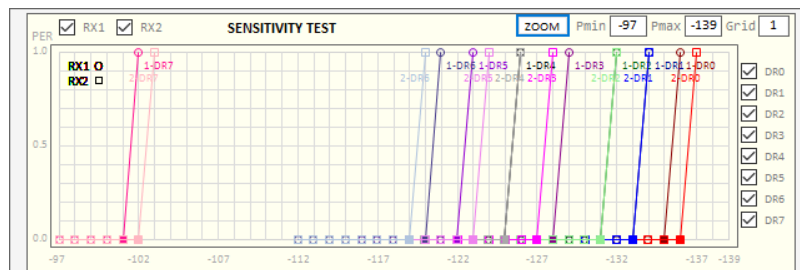

a. The result graph of PER test

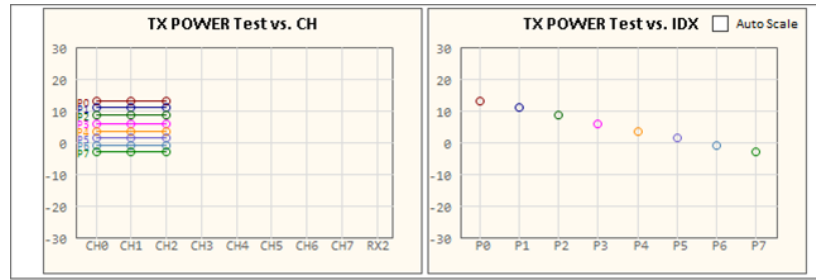

b. The result graph of power test

Fig 3.17 Show Result Graph of PER and TX Power

### 3.2.1.7 Viewing Remote commands

If  View SPY MSG is checked, it shows remote control commands and responses between the application and RWC5020x equipment.

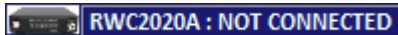

Fig 3.18 Remote Message

## 3.2.2 LBT TEST

RWC5020x application provides LBT (listen before talk) test function. An RWC2020A is required for this test. In this test, RWC5020x application assumes an RWC2020A is connected as an interferer.

Connect RWC5020x and RWC2020A with RS232 cable. RWC2020A will be controlled by RWC5020x through RS232 cable during LBT test. RWC2020A will make interference signals as you set up this RWC5020x application program.

RWC2020A can make single or multi-interferer signals up to 8 the same time. Users can check whether RWC2020A is connected or not with this icon and message 

### 3.2.2.1 Checking the connection to RWC2020A

User must check whether RWC2020A is connected or not before LBT test.

LBT test will not be run without RWC2020A LBT interferer.

### 3.2.2.2 Test Scenarios

The application provides two scenarios; channel and burst mode test.

In the channel mode test, RWC2020A transmits single tone to each channel that users selected simultaneously. Users can set the test duration, reference power, and relative sub-channel power of



RWC2020A interfering signal.

In the burst mode test, RWC2020A alternatively transmits multi-tones according to the time schedule. Users can set up the time duration of each signal burst.

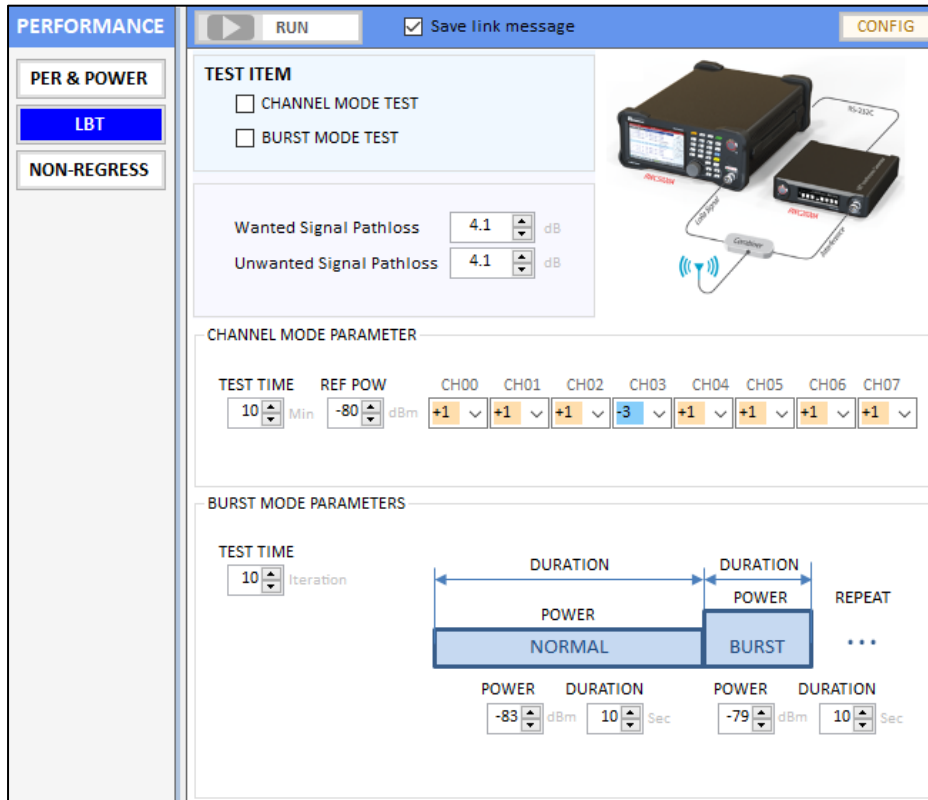
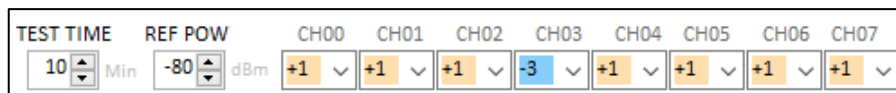

Fig 3.19 LBT Scenario configuration window

### 3.2.2.3 Channel mode test

Users can configure the reference power and relative sub channel power of RWC2020A interfering signal. If you set channel relative powers same as figure 3.20, RWC2020A will generate eight interference channels and set the absolute powers same as the values shown in the figure 3.20.



a. Relative channel powers

CH	CH00	CH01	CH02	CH03	CH04	CH05	CH06	CH07
Actual Power(dBm)	-79	-79	-79	-83	-79	-79	-79	-79

b. Absolute channel power table

Fig 3.20 LBT Channel power configuration

### 3.2.2.4 Burst mode test

In burst mode test, users can configure the power and the duration of each burst signal as well as test iteration. RWC2020A alternatively transmits two burst signals according to the power and duration.

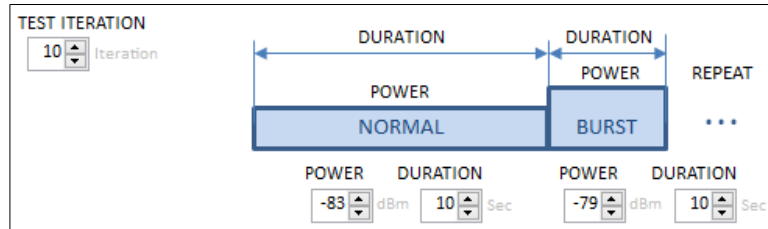

Fig 3.21 LBT Burst channel configuration

### 3.2.2.5 Starting LBT test and result

Click on and RWC5020x will start the communication with DUT and RWC2020A will generate interference signal. While testing, RWC5020x will count up received packets per channel and display the result. The DUT shall not use channels whose interference signal is above the reference value.

## 3.2.3 NON-REGRESSION TEST

This test function is only for gateways, and it will be activated under the gateway type of DUT test.

The screenshot shows the RedwoodComm LoRaWAN Autotest software interface. The main window is titled 'PERFORMANCE - NON-REGRESSION OF GW'. The interface is divided into several sections:

- PROJECT SETUP:** PROJECT: DEMO\_V1310, PATH: D:\project\LoRa\gui\DEMO\_V1310\DEMO\_V1310, DUT: NEW, GWT\_EU868\_V183\_ClassA\_NRT, REPORT PATH: D:\project\LoRa\gui\DEMO\_V1310\DEMO\_V1310\GWT\_EU868\_V103\_ClassA\_NRT.
- PERFORMANCE:** Includes buttons for 'RUN', 'SKIP', and 'GW IP'. The 'NON-REGRESS' tab is selected.
- TEST ITEM:** Includes checkboxes for 'TX OUT POWER MEASUREMENT', 'PER/RSI/SNR', 'SENSITIVITY', 'FREQUENCY ERROR TOLERANCE', and 'CW INTERFERER IMMUNITY'. The 'PER/RSI/SNR' checkbox is checked.
- FREQUENCY/SF:** Includes checkboxes for various frequencies (868.3000, 868.5000, 868.7000) and SF values (SF7BW125, SF8BW125, SF9BW125, SF10BW125, SF11BW125, SF12BW125, SF8BW500).
- PATHLOSS:** Includes a dropdown for 'RWC5020x' and 'RWC2020A', and a value of 0.0 dB.
- TX INTERVAL:** Includes a value of 0.2 Sec.
- PER/RSI/SNR TEST PARAMETERS:** Includes a '# PACKET' value of 10.
- MONITOR:** Includes checkboxes for 'Show Result Values' and 'Show JSON PKT'. A table shows test conditions: DUT NAME: GWT\_EU868\_V183\_ClassA\_NRT, TEST EQUIPMENT: RuC5020x, PATHLOSS: 4, NUMBER OF PACKETS: 10, PAYLOAD SIZE: 16, POWER STEP: 108, ELAPSED TIME: 03:07:11.
- RESULT INFO:** Includes 'PER/RSI/SNR' and 'PER vs. POWER' graphs. The 'PER vs. POWER' graph shows a sharp drop in PER at a certain power level.
- JSON PACKET MONITOR:** Shows a list of received packets, including 'Sent: PUSH\_ACK' and 'rxpk' data.

Fig 3.22 Non-regression test control and parameters window

RWC5020x application program provides a new test method to verify gateway's RF performance without an external network server, which is a part of non-regression tests for gateways defined by SEMTECH. You do not need to connect your gateway to any other network server because the RWC5020x application works as a network server. The test concept is shown in the fig 3.23.

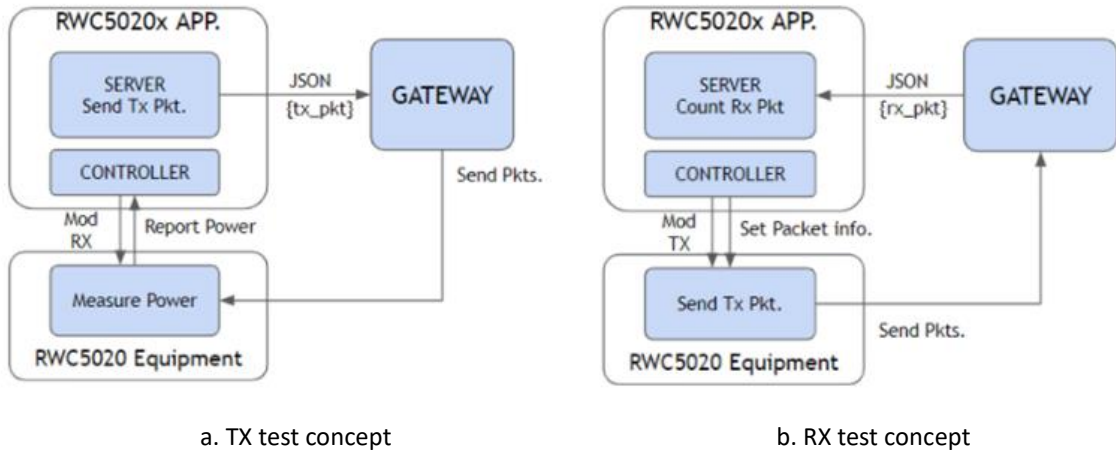

Fig 3.23 Test concept of the Non-regression test with RWC5020x

Users need to connect the DUT with the RWC5020x measurement equipment, and RWC2020A interference signal if needed, and the PC that runs the RWC5020x application program acting as a server and a measurement controller, as shown in Figure 3.24 below.



Fig 3.24 The Concept of non-regression test of gateways

In order to let RWC5020x know the IP and the destination port of gateway, users have to set them manually. You can select the network adapter which has the actual IP address of the RWC5020x application running.

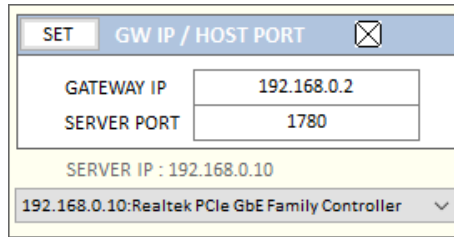

Fig 3.25 The IP and PORT setup for non-regression test

Non-regression test consists of 5 automated test function such as TX output power calibration, PER/RSSI/SNR, sensitivity, frequency error tolerance, CW interferer immunity test, and inter-modulation immunity. RWC5020x application program provides minimal amount of server functionality to respond to the request from a gateway. If you set the  Show JSON PKT checked, a monitor box appears and shows all JSON packets transmitted and received during the test.

### 3.2.3.1 TX output power calibration

This function measures TX output power of the DUT (gateway) and shows the power properties and makes property table.

In this test, the RWC5020x application program makes DUT transmit signal according to the setup power through LAN with JSON and RWC5020x equipment measures the TX power of the DUT. Users can use this function as a calibrator for gateway.

User can set up power start, power step, number of powers, and number of packets.



Fig 3.26 Parameters for TX PWER CALIBRATION

Users cannot change stop power. It will be calculated according to the power start and power step values automatically.

### 3.2.3.2 PER/RSSI/SNR

This function measures the PER (packet error rate), reads and shows the RSSI(Rx Signal Strength Indication) and SNR(Signal to Noise Ratio) information from the gateway using JSON.

In this test, RWC5020x equipment transmits LoRa signal and RWC5020x application asks the gateway for RSSI, SNR and the number of received packets. RWC5020x application calculates PER using the number of packets that equipment sent and the number of packets that gateway received and shows the result graphically.

Power step is fixed at 1dB and Power range is also fixed.

The transmit payload is 'all zeros'. Users cannot modify the payload.

**PER/RSSI/SNR TEST PARAMETERS**

# PACKET  POW STEP 1 dB

Fig 3.27 Parameters for PER/RSSI/SNR

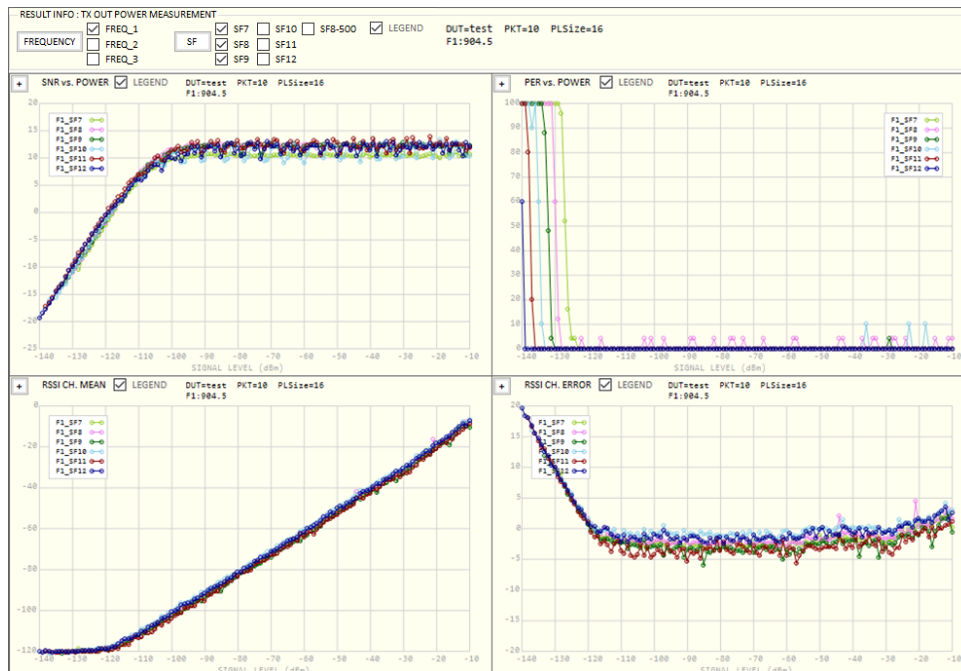

Fig 3.28 The test result of PER/RSSI/SNR

### 3.2.3.3 SENSITIVITY

This function measures the PER (packet error rate) with respect to the power and searches the sensitivity using the measured PER.

While testing, RWC5020x equipment transmits LoRa signal and RWC5020x application asks the gateway for the number of received packet. RWC5020x application calculates PER using the number of packets that the equipment sent and the number of packets that the gateway received and shows the result graphically.

The power step is fixed at 1dB and power range is also fixed in range -140 to -100dBm.

Users may modify only the number of packet. More packets will make more reliable results.

The transmit payload is 'all zeros'. Users cannot modify the payload.

**SENSITIVITY and PER TEST PARAMETERS**

# PACKET  POW STEP 1 dB

Fig 3.29 Parameters for SENSITIVITY

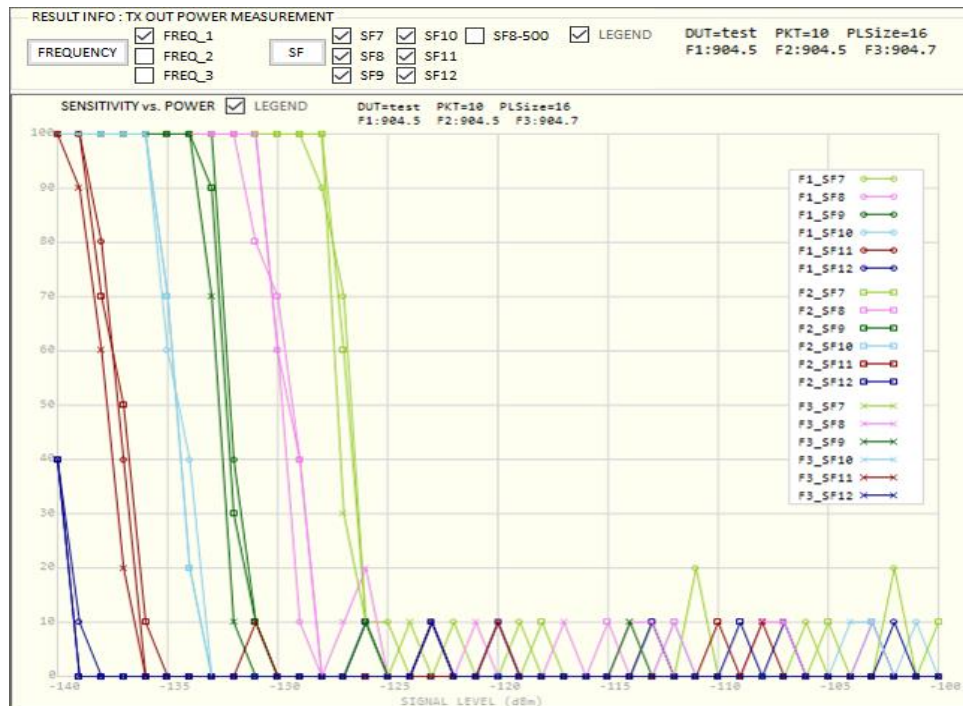

Fig 3.30 The test result of SENSITIVITY

### 3.2.3.4 Frequency error tolerance

This function measures the immunity properties with respect to the frequency error of the DUT (gateway) using the packet error rate. It is available only with RWC5020B and RWC5020M.

In this test, RWC5020B/M equipment transmits LoRa signal with frequency offset and RWC5020x application asks the gateway for the number of received packet and calculates PER using the number of packets that the equipment sent and the number of packets that DUT received. TX Power of RWC5020x is fixed at -100dBm and frequency offset step is fixed at 1.0 ppm. Users may modify the number of packets to be tested.

The transmit payload is 'all zeros'. Users cannot modify the payload.

**FREQUENCY TOLERANCE PARAMETERS**

# PACKET      10

POWER        -100.0 dBm

OFFSET STEP   1ppm

Fig 3.31 Parameters for FREQUENCY ERROR TOLERANCE

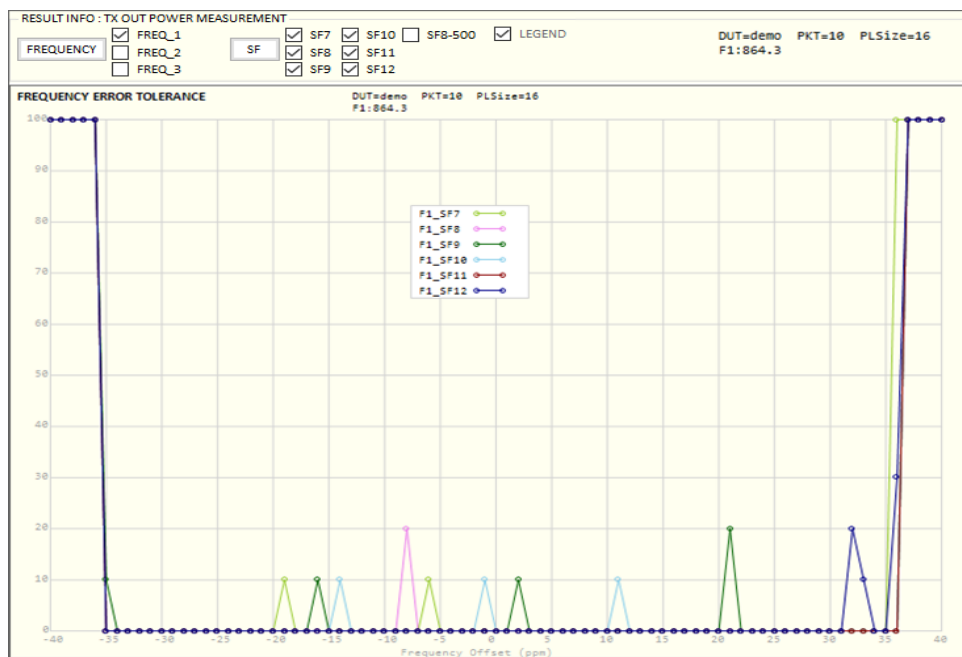

Fig 3.32 The test result of FREQUENCY ERROR TOLERANCE

### 3.2.3.5 CW immunity against the interferences with frequency offset.

This function measures the immunity properties of the gateway against interference signal of variant frequencies and powers.

In this test, RWC5020x equipment transmits LoRaWAN® signal as a wanted signal, RWC2020A transmits CW as an interference signal and RWC5020x application asks the gateway (DUT) for the number of received packet during the test.

**CW INTERFERER PARAMETERS**  
RWC5020x Signal Generator

PAYLOAD # PACKET 10 TARGET PER 0.500

SIGNAL POWER SF7 SF8 SF9 SF10 SF11 SF12 dBm

-121.0 -124.0 -127.0 -130.0 -133.0 -136.0

SF8BW500 -136.0 dBm

Fig 3.33 CW Interferer test parameters

RWC5020x application finds the interferer power level of the PER that meets target PER while calculating PER using the number of packet gateway received. Users can set payload size, number of packets, target PER, and each power for the each spreading factor respectively. The transmit payload is 'all zeros'. Users cannot modify the payload.

RWC2020A interferer generator is required to test CW interferer immunity shown in the figure 3.34.

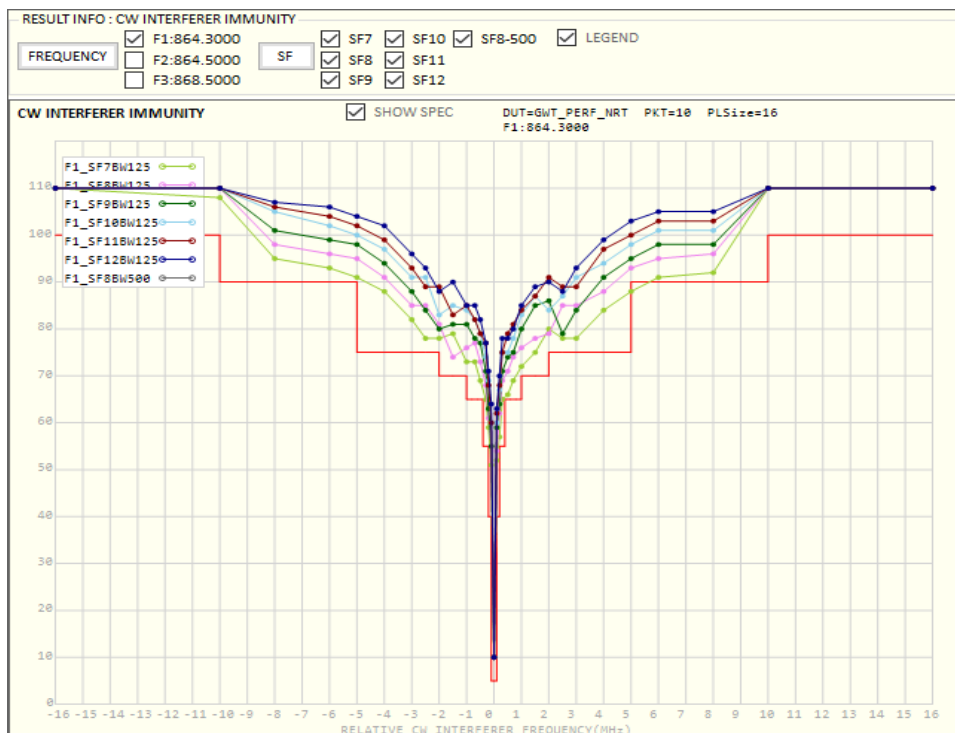

Fig 3.34 The test result of CW Interferer Immunity



### 3.2.3.6 Functionality condition

#### **Showing Result Values**

When you check  Show Result Values, all tested values will be shown in the result window. It can take a quite long time to display according to the result amount.

#### **Showing JSON packets during test**

When you check  Show JSON PKT, you can see JSON packets sending and receiving between SERVER and the DUT(Gateway) during test.

#### **Skipping current testing item**

If you click the [SKIP] button during test, the application will mark the current testing item as untested and start testing the next SF item which is checked.

## **3.3 Link Analyzer**

Using this function, you can monitor all operations of DUT and dump all link messages in user friendly format from RWC5020x while linking with DUT.

Link analyzer consists of Link message tool, script editor, and payload editor.

Using payload editor, users can send mac command(s) or user defined packet while linking.

In addition, using script editor addition, users can create a script and play it while linking. You can add or remove a group of commands named ACTION which includes single, multiple MAC commands, and user defined payload.

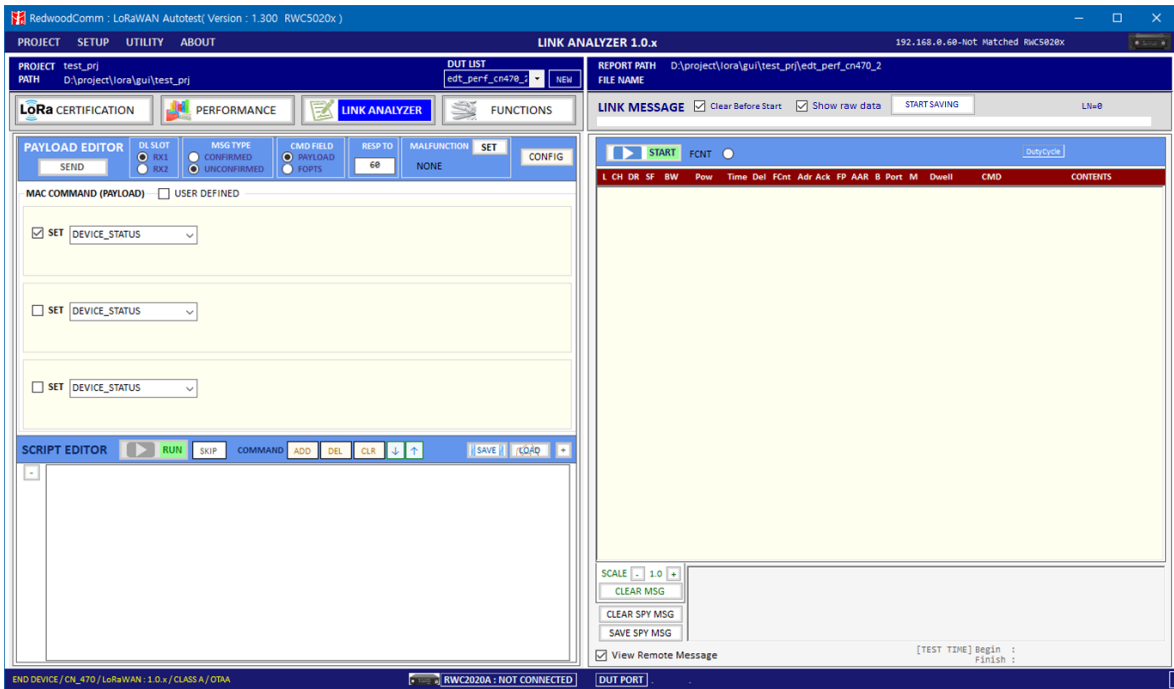





Fig 3.35 Link Analyzer

### 3.3.1 Saving link message

Click on  button in link message window and RWC5020x will start dumping all link messages between RWC5020x and DUT line by line. Clicking on  button will stop RWC5020x from dumping. All link messages can be saved any time with time stamped file name by clicking  on button. When you click the [START SAVING] button, the program starts saving the link message in real time, shows the saving status with a progress bar, and you can see the file name.

Change the naming option in the environment menu to specify the desired file name.

### 3.3.2 Payload editor

#### 3.3.2.1 Sending Commands

You can edit MAC commands in link script editor window. You can select single or multiple commands by checking one, two, or three  SET . When multiple  SET are selected, multiple MAC commands are added in a single frame. The maximum number of multiple MAC commands in a frame is limited to 3 on RWC5020x equipment.

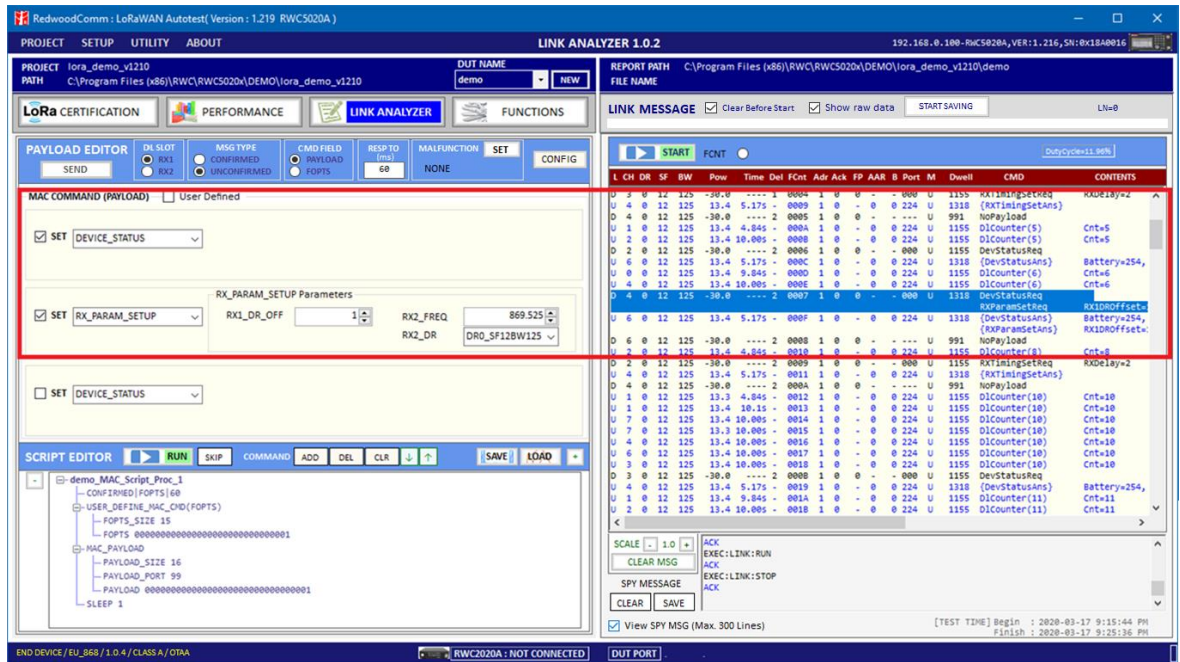

Fig 3.36 Sending multiple commands in a single packet

When  **User Defined** is checked, user definable command edit window will appear.

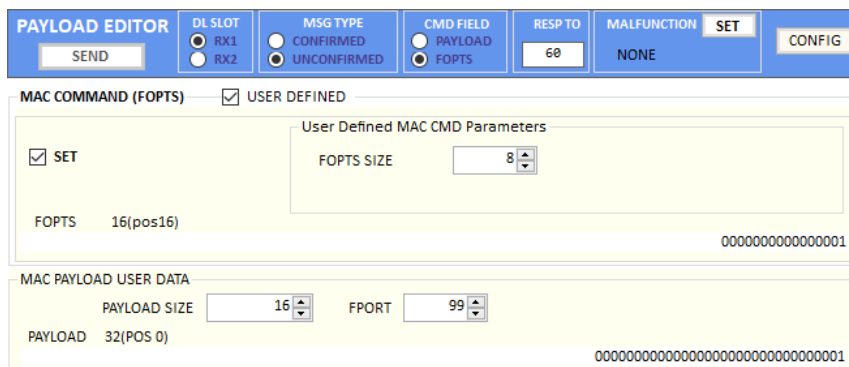

Fig 3.37 An Example for User defined commands in FOPTS and MAC PAYLOAD USER DATA

### 3.3.2.2 Malfunction test

Users can send the MAC commands which includes error intentionally inserted using malfunction. This function is also applied to GWT.

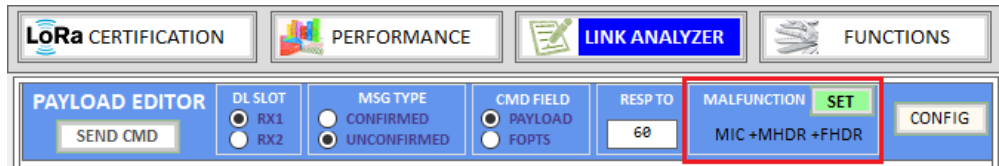

Fig 3.38 Malfunction status window in PAYLOAD EDITOR

### Test Procedure

**Activation** – Start link analyzer and make a activation with DUT.

**MAC command selection** - Select a mac command referring 3.3.2.1

**Malfunction Editing** - Click [SET] button in MALFUNCTION area and select the types of error which you want to add like fig. 3.36. To generate an intentional MIC error, set MIC\_ERROR to ON. To modify the MAC header part, set MHDR\_ERROR to ON and configure the XOR\_MHDR value. XOR\_MHDR value is exclusive OR with MAC Header. To modify the Frame header part, set FHDR\_ERROR to ON and configure the XOR\_FHDR value. XOR\_FHDR value is exclusive OR with Frame Header.

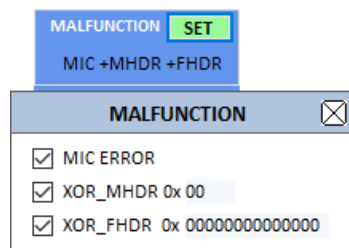

Fig 3.39 Malfunction configuration parameters

**MAC command transmission** - Clicking [SEND CMD] button will send MAC commands and malfunction setup commands to the equipment. Then RWC5020x will send the intentionally malfunctioned MAC command to the DUT.

### 3.3.2.3 Mac Commander Parameters

#### **DOWNLINK SLOT**

When RWC5020x emulates Gateway/Server mode (EDT), it could respond to the uplink frame by downlink frame using RX1 window or RX2 window. Using this parameter, users can select RX window for testing the DUT.



Fig 3.40 MESSAGE TYPE

#### **MAC\_CMD\_TYPE**

This parameter defines the type of MAC command to be transmitted: confirmed or unconfirmed.

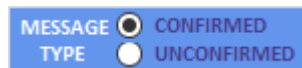

Fig 3.41 COMMAND FILED

#### **MAC\_CMD\_FIELD**

This parameter defines the type of field where MAC command is stored in a frame: payload or option field.



Fig 3.42 RESPONSE TIME OUT

#### **RESP TIMEOUT**

This parameter defines MAC answer time-out after sending MAC command.

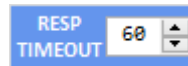

Fig 3.43 Response time out value

#### **FOPTS\_SIZE**

This parameter defines the size of FOpts field. This parameter is shown if MAC\_CMD\_FIELD set as FOPTION.

#### **FOPTS**

This parameter defines the content of FOpts in hexadecimal format. This parameter is shown if MAC\_CMD\_FIELD set as FOPTION.

#### **MAC\_CMD: DEV\_STATUS**

This parameter is for sending *DevStatusReq* command to DUT, which expects *DevStatusAns* command from it. *DevStatusReq* command requests the status of the End Device and does not have any parameter.

#### **MAC\_CMD: LINK\_ADR**

This parameter is for sending *LinkADRReq* command to DUT, which expects *LinkADRAns* command from it. *LinkADRReq* command requests the End Device to change data rate, transmit power, repetition rate or channel.

#### **ADR\_DR**

This parameter is the requested data rate of End Device for uplink message.

#### **ADR\_TXPOW**

This parameter is the requested output power of End Device for uplink message.

#### **ADR\_CH\_MASK**

This parameter encodes the channels usable for uplink access. A bit in the CH\_MASK field set to 1 means that the corresponding channel can be used for uplink transmissions.

#### **ADR\_MASK\_CTRL**

This parameter controls the interpretation of the previously defined CH\_MASK bit mask. It controls the block of 16 channels to which the CH\_MASK applies. It can also be used to globally turn on or off all channels using specific modulation.

#### **ADR\_NB\_TRANS**

This parameter is the number of transmissions for each uplink message.

#### **MAC\_CMD: DUTY\_CYCLE**

This parameter is for sending *DutyCycleReq* command to DUT, which expects *DutyCycleAns* command from it. *DutyCycleReq* command sets the maximum aggregated transmit duty-cycle of the End Device.

#### **MAX\_DUTY\_CYCLE**

This parameter is used by the network coordinator to limit the maximum aggregate transmit

duty cycle of an End Device.

**MAC\_CMD: RX\_PARAM\_SETUP**

This parameter is for sending *RXParamSetupReq* command to DUT, which expects *RXParamSetupAns* command from it. *RXParamSetupReq* command sets the reception slots parameters.

**RX1\_DR\_OFFSET**

This parameter sets the offset between the uplink data rate and the downlink data rate used to communicate with End Device on the first reception slot (RX1).

**RX2\_FREQ**

This parameter defines the frequency of a downlink using the second receive window.

**RX2\_DR** the data rate of a downlink using the second receive window

This parameter defines the data rate of a downlink using the second receive window.

**MAC\_CMD: TX\_PARAM\_SETUP**

This parameter is for sending *TXParamSetupReq* command to DUT, which expects *TXParamSetupAns* command from it. *TXParamSetupReq* command is used by the network server to set the maximum allowed dwell time and Max EIRP of End Device, based on local regulations.

**MAX\_EIRP**

This parameter corresponds to an upper bound on the device’s radio transmit power. The device is not required to transmit at that power, but shall never radiate more that this specified EIRP.

<b>Coded Value</b>	0	1	2	3	4	5	6	7	8	9	10	11	12	13	14	15
<b>Max EIRP (dBm)</b>	8	10	12	13	14	16	18	20	21	24	26	27	29	30	33	36

**UL\_DWELL\_TIME**

This parameter corresponds to the maximum allowed dwell time for uplink transmissions.

**DL\_DWELL\_TIME**

This parameter corresponds to the maximum allowed dwell time for downlink transmissions.

**MAC\_CMD: NEW\_CHANNEL**

This parameter is for sending *NewChannelReq* command to DUT, which expects *NewChannelAns* command from it. *NewChannelReq* command creates or modifies the definition of a radio channel.

**NEW\_CH\_MODE**

This parameter can be used to either modify the parameters of an existing bidirectional channel or to create a new one. To create or modify the channel, set this parameter as 'CREATE'. To delete the channel, set this parameter as 'DELETE'

#### **NEW\_CH\_INDEX**

This parameter is the index of the channel being created or modified.

#### **NEW\_CH\_MAX\_DR**

This parameter designates the highest uplink data rate allowed on this channel.

#### **NEW\_CH\_MIN\_DR**

This parameter designates the lowest uplink data rate allowed on this channel.

### **MAC\_CMD: DL\_CHANNEL**

This parameter is for sending *DIChannelReq* command to DUT, which expects *DIChannelAns* command from it. *DIChannelReq* command sets the network to associate a different downlink frequency to the RX1 slot.

#### **DL\_CH\_INDEX**

This parameter is the index of the channel whose downlink frequency is modified.

#### **DL\_CH\_FREQ**

This parameter is the corresponding downlink frequency value of a 24 bits unsigned integer. The actual downlink frequency in Hz is  $100 \times \text{DL\_CH\_FREQ}$ .

### **MAC\_CMD: RX\_TIMING\_SETUP**

This parameter is for sending *RXTimingSetupReq* command to DUT, which expects *RXTimingSetupAns* command from it. *RXTimingSetupReq* command sets the timing of the of the reception slots.

#### **RECEIVE\_DELAY**

The first receive window RX1 opens RECEIVE\_DELAY seconds after the end of the uplink modulation.

### **MAC\_CMD: USER\_DEFINED**

This parameter is for sending a user-defined command to DUT, which includes user-defined data of user-defined length.

#### **FPORT**

This parameter defines the FPort number of a user-defined MAC Command.



#### **PAYLOAD\_SIZE**

This parameter defines the size of payload of a user-defined MAC Command.

#### **PAYLOAD**

This parameter defines the content of payload in hexadecimal format.

#### **MAC\_CMD: ACTIVATE\_TM**

This parameter is for sending *Activate test mode* command to DUT, which starts test mode when 4 bytes payload with value 0x01010101 is sent to DUT.

#### **MAC\_CMD: DEACTIVATE\_TM**

This parameter is for sending *Deactivate test mode* command to DUT, which stops test mode and the DUT goes back to normal applicative operation.

#### **MAC\_CMD: CONFIRMED\_TM**

This parameter is for sending *Confirmed frames* command to DUT, which requests DUT to send the consequent uplink packets with a message type 'Confirmed'. It may be meaningful only after certification test mode is enabled by *Activate test mode* command.

#### **MAC\_CMD: UNCONFIRMED\_TM**

This parameter is for sending *Unconfirmed frames* command to DUT, which requests DUT to send the consequent uplink packets with a message type 'Unconfirmed'. It may be meaningful only after certification test mode is enabled by *Activate test mode* command.

#### **MAC\_CMD: ECHO\_REQUEST\_TM**

This parameter is for sending *EchoRequest* command to DUT, which requests DUT to reply with *EchoResponse*. It may be meaningful only after certification test mode is enabled by *Activate test mode* command.

#### **ECHO\_LEN**

This parameter indicates the length of payload in *EchoRequest* command.

#### **PAYLOAD**

This parameter defines the content of payload in hexadecimal format.

#### **MAC\_CMD: TRIGGER\_JOIN\_REQ\_TM**

This parameter is for sending *Trigger Join Request* command to DUT, which requests DUT to send *Join-request*. It may be meaningful only after certification test mode is enabled by *Activate test mode* command.

#### **MAC\_CMD: ENABLE CW MODE TM**

This parameter is for sending *Enable Continuous Wave Mode* command to DUT, which requests DUT to send continuous wave (CW) signal based on the values in the payload. It may be meaningful only after certification test mode is enabled by *Activate test mode* command.

#### **CW\_TIMEOUT**

This parameter indicates the timeout for CW transmission.

#### **CW\_FREQ**

This parameter indicates the frequency of CW signal.

#### **CW\_POW**

This parameter indicates the power of CW signal.

#### **MAC\_CMD: BEACON\_FREQ**

This parameter is for sending *BeaconFreqReq* command to DUT, which expects *BeaconFreqAns* command from it. *BeaconFreqReq* command sets the network to associate new beacon frequency

#### **BEACON\_FREQ**

This parameter is the corresponding beacon frequency value of a 24 bits unsigned integer.

#### **MAC\_CMD: PING\_SLOT\_CH\_REQ**

This parameter is for sending *PingSlotChannelReq* command to DUT, which expects *PingSlotFreqAns* command from it. *PingSlotChannelReq* command modifies the frequency and/or the data rate on which the end-device expects the downlink pings

#### **PING\_DR**

This parameter is the index of the Data Rate used for the ping-slot downlinks.

#### **PING\_FREQ**

This parameter is the corresponding ping channel frequency value of a 24 bits unsigned integer. The actual ping channel frequency in Hz is 100 x PING\_FREQ.

#### **MAC\_CMD: FORCE\_REJOIN**

This parameter is for sending *ForceRejoinReq* to DUT, which expects no answer from it. With the *ForceRejoinReq* command, the network asks a device to immediately transmit a Rejoin-Request Type 0 or type 2 message with a programmable number of retries, periodicity and data rate.

**REJOIN\_DR**

This parameter is the data rate of Rejoin-Request.

**REJOIN\_TYPE**

This parameter is the type of Rejoin-Request.

**REJOIN\_RETRY**

This parameter is the total number of times DUT will retry Rejoin-Request.

**REJOIN\_PERIOD**

This parameter is the delay between retransmissions. The actual delay is  $32 \times 2^{\text{Period}} + \text{Rand32}$  seconds, where Rand32 is a pseudo-random number in the [0:32] range.

**MAC\_CMD: REJOIN\_SETUP**

This parameter is for sending *RejoinParamSetupReq* command to DUT, which expects *RejoinParamSetupAns* command from it. *RejoinParamSetupReq* command sets the network to request DUT to periodically send a *RejoinReq* Type 0 message with a programmable periodicity defined as a time of a number of uplinks.

**REJOIN\_MAX\_TIME\_N**

This parameter is the max time T. DUT must send a Rejoin-Request Type 0 at least every  $2^{T+10}$  seconds.

**REJOIN\_MAX\_CNT\_N**

This parameter is the max count C. DUT must send a Rejoin-Request Type 0 at least every  $2^{C+4}$  uplink messages.

**MAC\_CMD: ADR\_SETUP**

This parameter is for sending *ADRParamSetupReq* command to DUT, which expects *ADRParamSetupAns* command from it. *ADRParamSetupReq* command allows changing the *ADR\_ACK\_LIMIT* and *ADR\_ACK\_DELAY* parameters defining the ADR back-off algorithm.

**ADR\_LIMIT\_EXP**

This parameter is used to set *ADR\_ACK\_LIMIT* parameter value:

$$\text{ADR\_ACK\_LIMIT} = 2^{\text{ADR\_LIMIT\_EXP}}$$

### ADR\_DELAY\_EXP

This parameter is used to set ADR\_ACK\_DELAY parameter value:

$$\text{ADR\_ACK\_DELAY} = 2^{\text{ADR\_DELAY\_EXP}}$$

### 3.3.3 Script editor

This function provides a method to create a scenario that sends mac commands sequentially. The scenario consists of actions which includes a single or multiple commands, information, and sleep time that creates wait times in between actions. Users can add, remove, or edit a single or multiple commands in an action and modify the wait time.

You can edit MAC commands in link script editor window using      buttons.

#### 3.3.3.1 Adding commands

In order to add an action, have SET checked with at least one command which you want to add. By clicking [add] button you can add commands and parameters in action format.

Script editor does not check if the commands are the same or not. It means same commands could be added in single action. You must check whether it is intended or not by yourself.

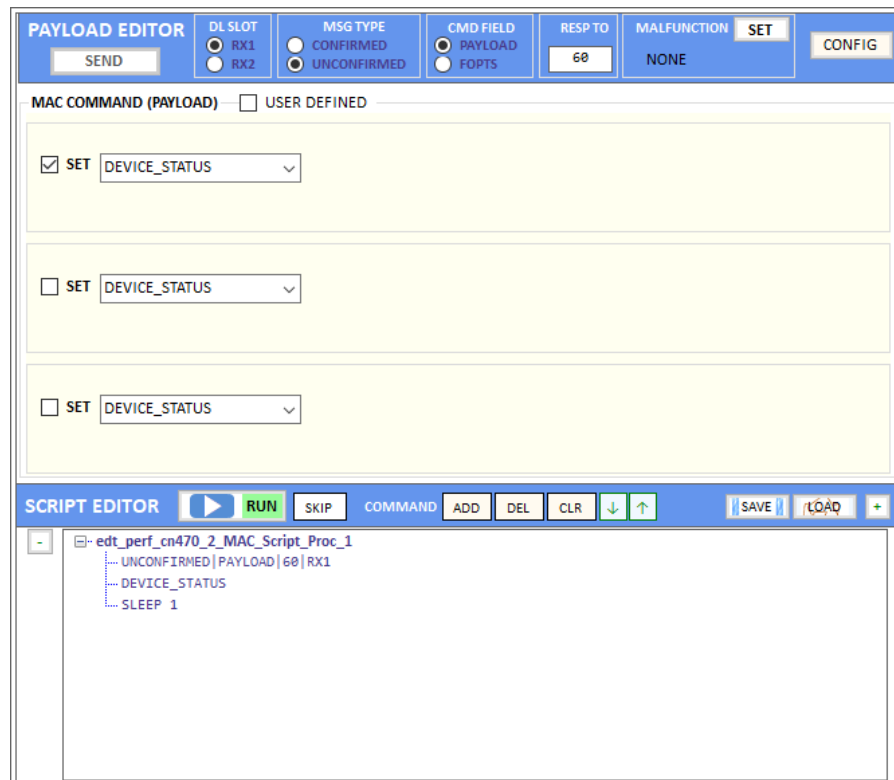

Fig 3.44 Adding an action into Script Editor

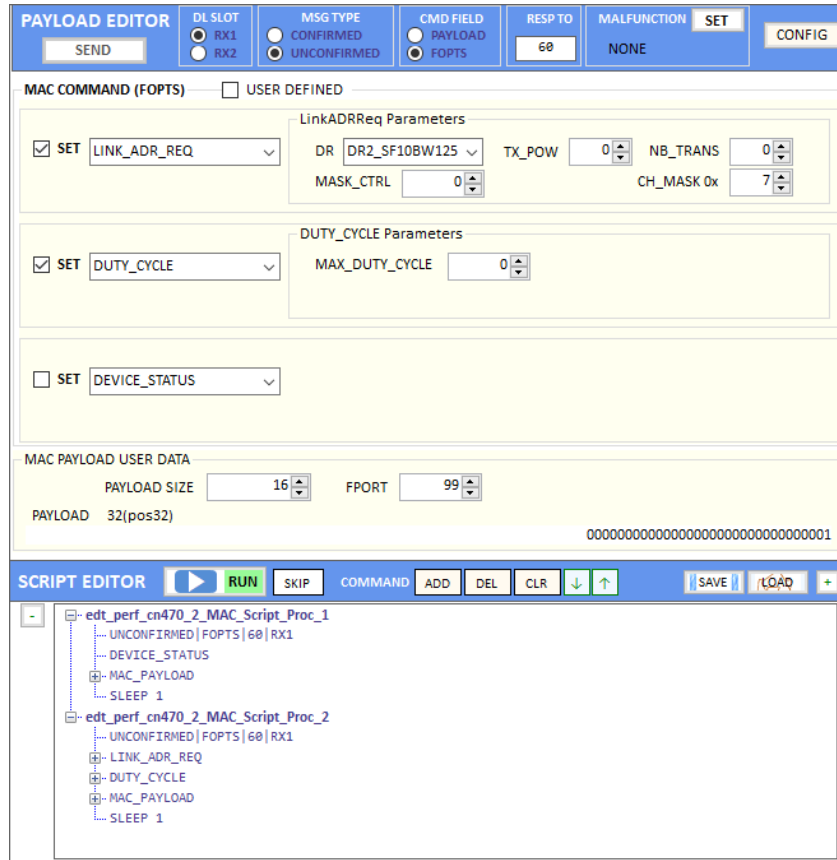

Fig 3.45 Adding an action that includes two commands

SLEEP function makes RWC5020x wait for a certain duration of time before sending the next command. The duration of wait time can be edited by the users.

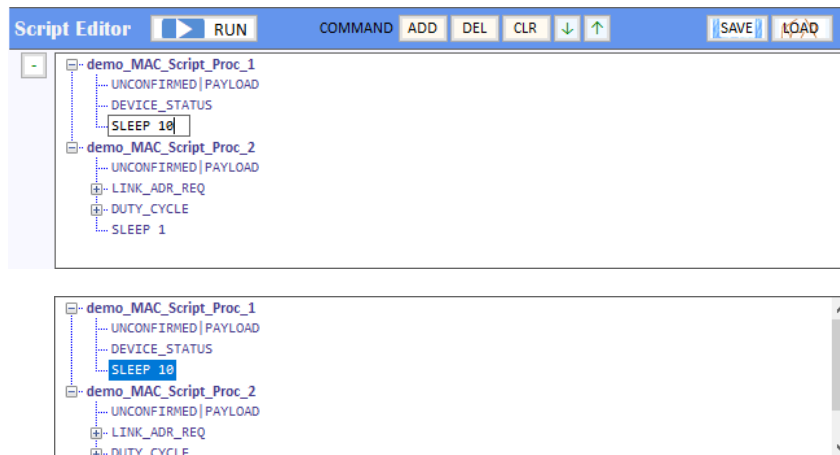

Fig 3.46 Editing SLEEP time between actions

### 3.3.3.2 Moving commands

You can move actions up or down using   buttons. At first select an action and move it.

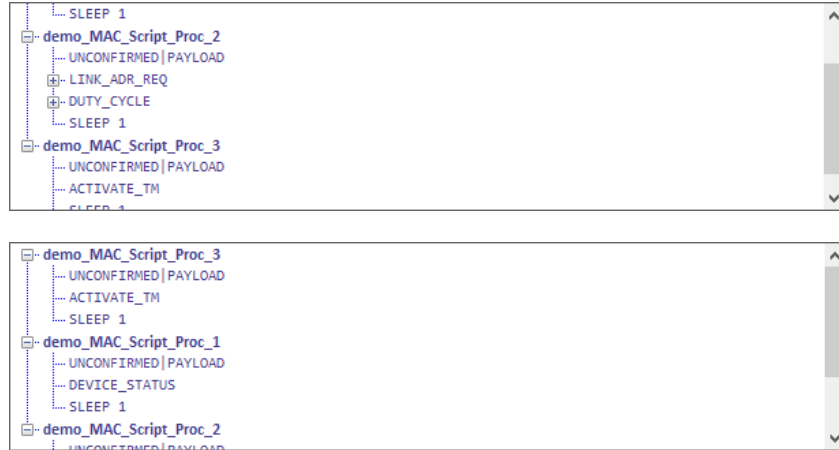

Fig 3.47 Moving an action.

### 3.3.3.3 Deleting actions

You can delete actions by clicking [DEL] button. Script editor will not ask whether you want to delete it or not. Therefore, use [DEL] button carefully to not delete any commands.

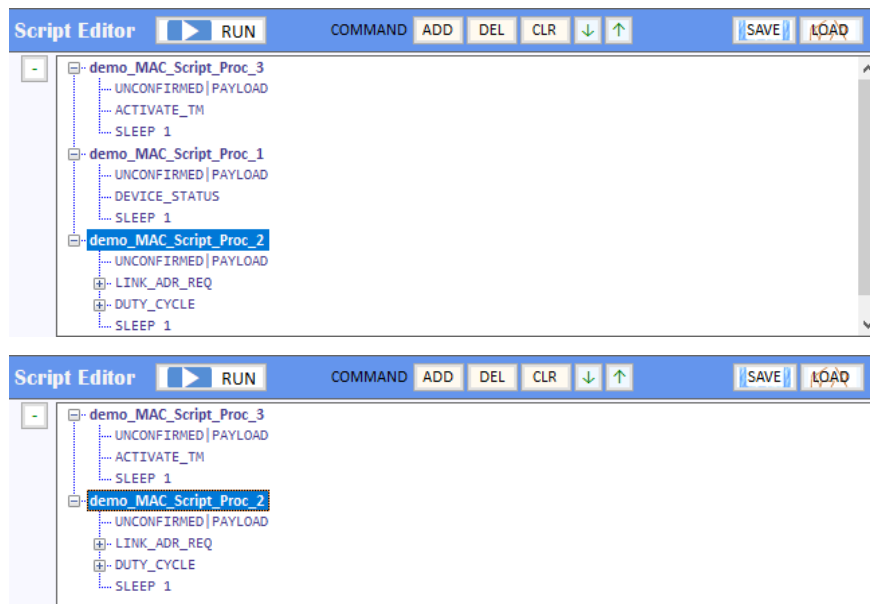

Fig 3.48 Deleting an action.

### 3.3.3.4 Renaming actions

You can edit the names of the actions or parameters and even commands.

Click left mouse button to edit. The Application will not verify you whether they are actions, parameters or the commands. Rename very carefully not to rename the commands.

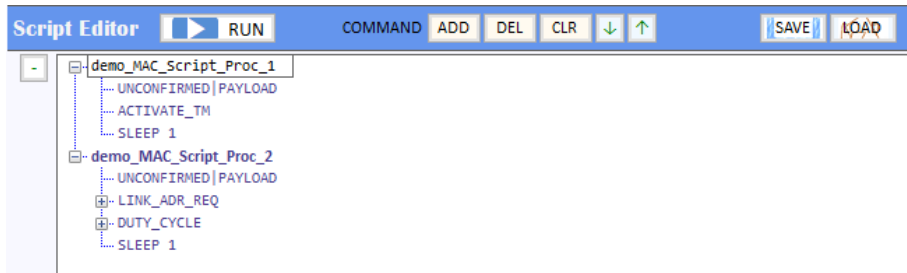

Fig 3.49 Renaming action title.

Define the PAYLOAD TYPE as UNCONFIRMED or CONFIRMED and define the CMD FIELD as PAYLOAD or FOPTION. You can verify what you selected from action's information [UNCONFIRMED|FOPTION|224](#)

### 3.3.3.5 Running actions

Clicking **Script Editor** **RUN** will make RWC5020x send MAC commands to DUT according to the script. Before running script, RWC5020x must be in running link analyzer. If it is not in running link analyzer, the application will let RWC5020x run link analyzer automatically while running script.

[RUN] button will be activated after creating a project and DUT and connection with RWC5020x is complete. While running, it indicates the item that is being tested and shows tested results beside the commands that have been sent as follows.

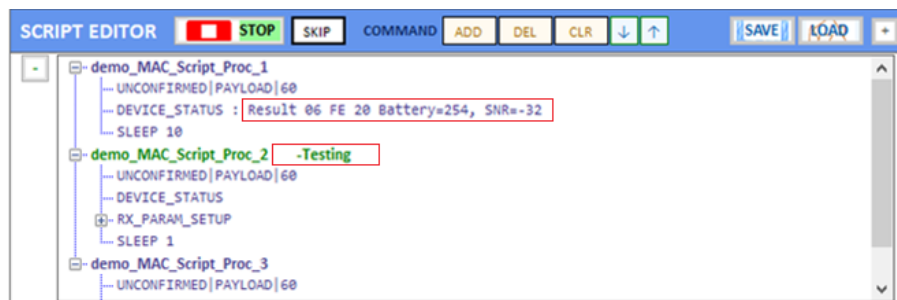



Fig 3.50 Running script screen

### 3.3.3.6 Saving Script

You can save the script to keep what you have edited. After modifying your script, click **SAVE** and select a

folder to decide where you want to save it.

### 3.3.3.7 Opening Script

You can recall the saved script you edited previously. Just click  and select the saved script file.

## 3.4 Functions

It has four special functions such as MFG, NST SG(Signal Generator), NST SA(Signal Analyzer) and FUOTA TEST.

### 3.4.1 MFG (Manufacturing)

This function is for a quick test for manufacturing. It helps users measure PER and the TX power of DUT very fast and easily.

For this function, a special function has to be prepared in DUT first. In the special mode of DUT, transmitting MEAS\_START\_FLAG, counting packets, recognizing MEAS\_STOP\_FLAG, and transmitting three same report frames functions should be prepared.

For the DUT information, “user data” such as serial number can be added in the MEAS\_START\_FLAG packet.

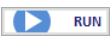
Clicking on  will make RWC5020x start waiting for the MEAS\_START\_FLAG MFG from DUT.

#### 3.4.1.1 Test concept

MEAS\_START\_FLAG packet transmitted from DUT will make RWC5020x start transmitting packets to DUT at the power specified by users. After transmitting the MEAS\_START\_FLAG, DUT must switch to RX mode to receive packets from RWC5020x and count the number of the packets received.

After transmitting all packets, RWC5020x will transmit MEAS\_END\_FLAG packet that stops DUT from counting and report the number of received packets.

After receiving the MESA\_END\_FLAG from RWC5020x, DUT must transmit report frame including the number of received frames three times within TIMEOUT time.

Whenever DUT transmits any frame RWC5020x measures the TX power of DUT and show the averaged value after receiving report packets.



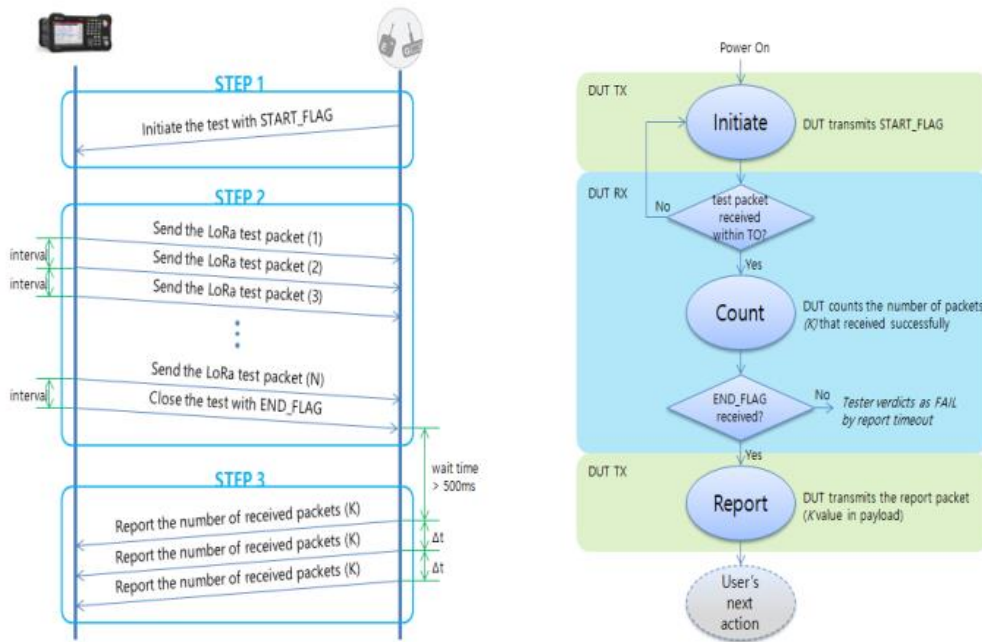

a. MFG procedure

b. Requirement operation for DUT

Fig 3.51 Test scenario for manufacturing

### 3.4.1.2 Protocol Parameters

#### **MODULATION**

This parameter defines the modulation type of MFG test; LoRa, FSK or CW.

#### **NETWORK**

This parameter indicates the type of LoRa network (synchronization word) to be used in LoRa modulation in MFG test.

#### **SF**

This parameter defines the spreading factor of a LoRa test frame to be used in MFG test. If this value is set as ANY, RWC5020x receives any kind of SF packets and apply this SF value for TX packets.

#### **BW**

This parameter defines the bandwidth of a LoRa test frame to be used in MFG test.

**CR**

This parameter defines the coding rate of a LoRa test frame to be used in MFG test, which is applicable only when DUT\_TYPE is 'GATEWAY'.

**TX POLARITY**

This parameter defines the TX signal polarity.

**RX POLARITY**

This parameter defines the RX signal polarity.

**PREAMBLE\_SIZE**

This parameter defines the preamble size of a LoRa test frame to be used in MFG test.

**PAYLOAD\_SIZE**

This parameter defines the size of payload of LoRa test frame in MFG test.

**PAYLOAD**

This parameter defines the content of payload in hexadecimal format in MFG test.

**FM\_DEVIATION**

This parameter defines the FM deviation value for FSK modulation.

**DATA\_RATE**

This parameter defines the data rate value for FSK modulation.

**SYNC\_WORD\_SIZE**

This parameter defines the Sync word size for FSK modulation

**SYNC\_WORD**

This parameter defines the Sync word for FSK modulation

**REPEAT\_NUM**

This parameter defines the number of transmission of a LoRa test frame to be used in MFG test.

**INTERVAL**

This parameter defines the time interval between consecutive LoRa test frames to be used in MFG test.

**PER\_CRITERIA**

This parameter defines the user's criteria of the result value of PER measurement in MFG test.

**POW\_CRITERIA\_UPPER**

This parameter defines the user's upper criteria of the result value of Power measurement in MFG test.

**POW\_CRITERIA\_LOWER**

This parameter defines the user's lower criteria of the result value of Power measurement in MFG test.

**TIME\_OUT**

This parameter defines the timeout until RWC5020x waits for a LoRa frame from DUT.

3.4.1.3 RF Parameters

**TX\_POW**

This parameter defines the output power of RWC5020x in dBm.

**FREQ**

This parameter defines the frequency of RWC5020x

**PATH\_LOSS**

Users can set the path loss between RF port of RWC5020x and DUT RF port. The measured power will be compensated with the defined path loss.

### **RX\_GAIN**

The RWC5020A/B has an AGC (Automatic Gain Control) function. So the RWC5020A/B will set appropriate RX gain after receiving a few packets from the DUT. This parameter defines the initial RX gain when the Link is started. It is very important to set this parameter correctly to get the proper test result quickly. Set to LOW if the expected input level from your DUT to RWC5020A/B is higher than 15dBm. Set to HIGH if the expected input level is lower than -40dBm. Otherwise set it to MIDDLE.

### **RX\_GAIN\_WARNING\_TO**

If RWC5020x does not receive RX packets for a while, RWC5020x assumes that RX\_GAIN may be incorrect and displays a notification. This parameter defines the timeout period for this notification.

### **RX\_AGC**

This parameter determines whether RX Gain is automatically adjusted or not

#### 3.4.1.4 Getting the result

Users can take measured result of the PER and the TX Power of DUT using remote commands.

Commands for

Reading the measured power of DUT :	READ:NST:MFG:POW?
Reading the measured PER of DUT :	READ:NST:MFG:PER?
Reading the user data in MEAS_START_FLAG frame :	READ:NST:MFG:DUT_INFO?

For all other remote commands, refer to the Remote Control Programming manual.

In figure 3.52, you can find an example test result with the MFG function. And refer the application note RAN502004R5 for more detailed operation and application with MFG.

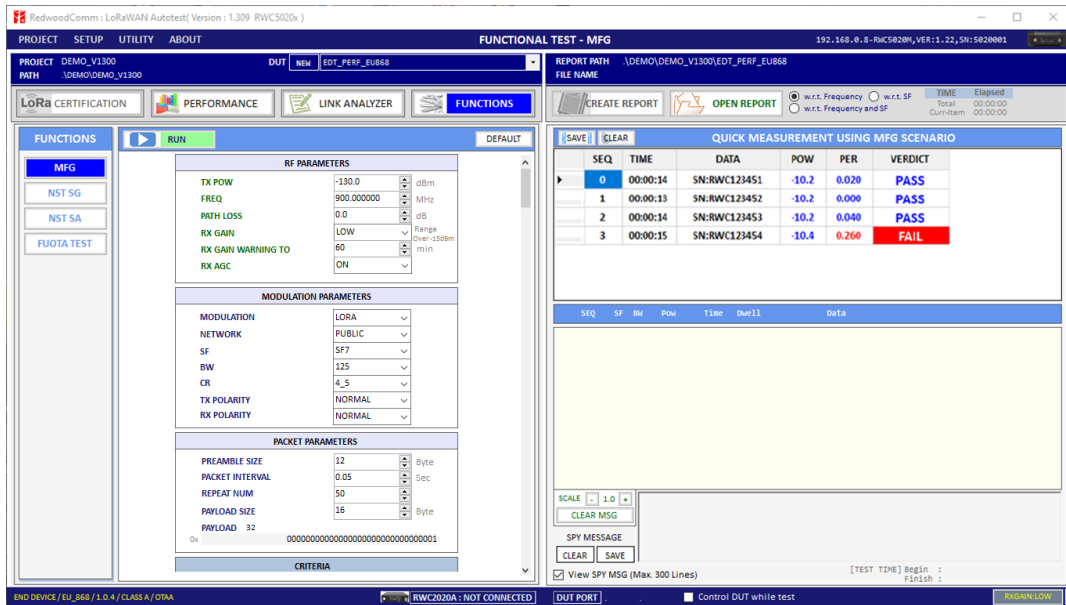

Fig 3.52 Example test using 4 DUTs(N=50, Target PER=0.1)

### 3.4.2 NST SG (Signal Generator)

Signal Generator is a function of transmitting the defined test waveform to DUT repeatedly. Three different modulations are provided: LoRa, FSK and CW.

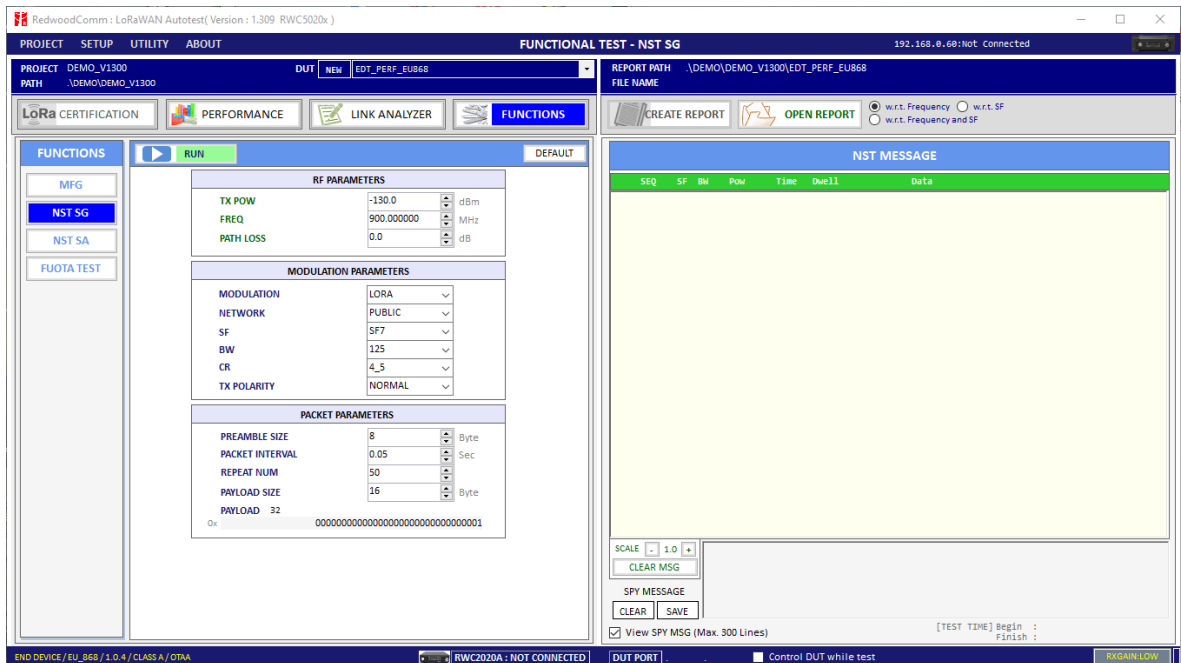

Fig 3.53 NST SG parameters and report window

### 3.4.2.1 Protocol Parameters

#### **MODULATION**

This parameter defines the modulation type of Signal Generator; LoRa, FSK or CW.

#### **DUT\_TYPE**

This parameter defines the DUT type of Signal Generator; End\_device, Gateway, Unknow. TX signal polarity and CR value will be set automatically depends on DUT type.

#### **NETWORK**

This parameter indicates the type of LoRa network (synchronization word) to be used in LoRa modulation.

#### **SF**

This parameter defines the spreading factor of a LoRa test frame.

#### **BW**

This parameter defines the bandwidth of a LoRa test frame.

#### **CR**

This parameter defines the coding rate of a LoRa test frame, which is applicable only when DUT\_TYPE is 'GATEWAY'.

#### **PREAMBLE\_SIZE**

This parameter defines the preamble size of a LoRa test frame.

#### **PAYLOAD\_SIZE**

This parameter defines the size of payload of LoRa test frame.

#### **PAYLOAD**

This parameter defines the content of payload in hexadecimal format.

**FM DEVIATION**

This parameter defines the FM deviation value for FSK modulation.

**DATA RATE**

This parameter defines the data rate value for FSK modulation.

**SYNC WORD SIZE**

This parameter defines the Sync word size for FSK modulation

**SYNC WORD**

This parameter defines the Sync word for FSK modulation

**TX POLARITY**

This parameter defines the TX signal polarity.

**REPEAT NUM**

This parameter defines the number of transmission of a LoRa test frame.

**INTERVAL**

This parameter defines the time interval between consecutive LoRa test frames.

### 3.4.2.2 RF Parameters

**TX POW**

This parameter defines the output power of RWC5020x in dBm.

**FREQ**

This parameter defines the frequency of RWC5020x.

**PATH LOSS**

User can set the path loss between RF port of RWC5020x and DUT RF port. RWC5020x's real output power will be increased by this value to compensate path loss.

### SYSCLK\_OFFSET

This parameter defines the system clock frequency (32MHz) offset value in ppm. It modifies RF frequency as well as LoRa modulation signal.

### 3.4.3 NST SA (Signal Analyzer)

Signal Analyzer is a function of analyzing LoRa frames received from DUT repeatedly.

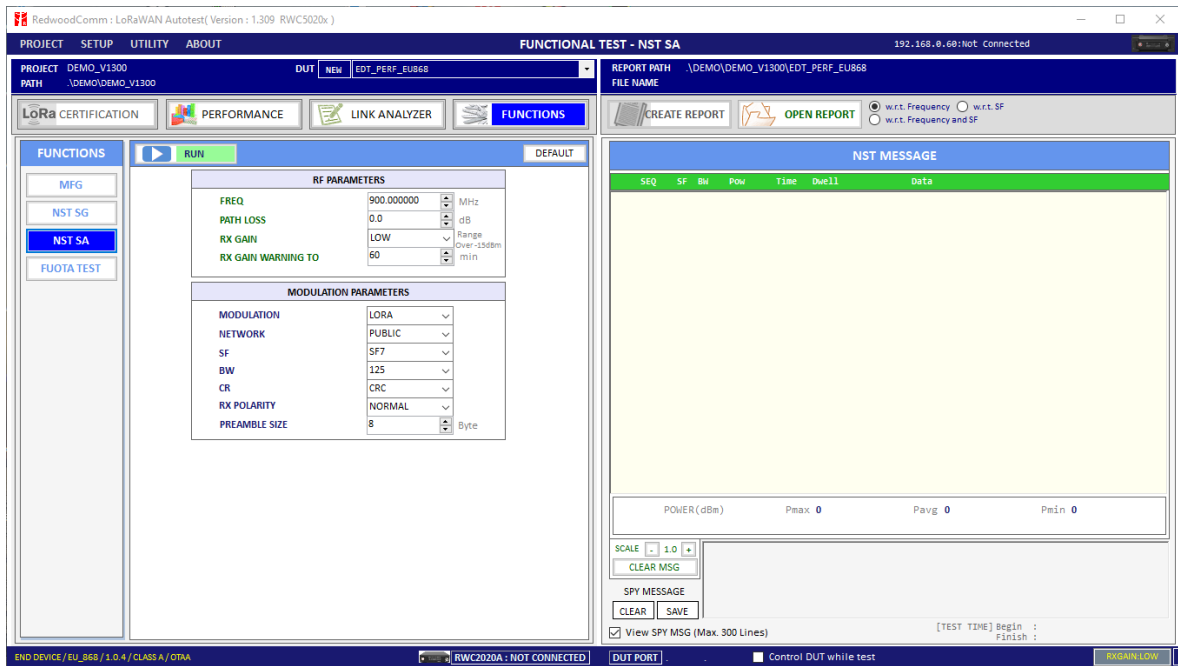

Fig 3.54 NST SA parameters and report window

#### 3.4.3.1 Protocol Parameters

### MODULATION

This parameter defines the modulation type of Signal Analyzer; LoRa, FSK or CW.

### DUT\_TYPE

This parameter defines the DUT type of Signal Analyzer; End\_device, Gateway, Unknow. RX signal polarity and CR value will be set automatically depends on DUT type.



### **NETWORK**

This parameter indicates the type of LoRa network (synchronization word) to be used in LoRa modulation.

### **SF**

This parameter defines the spreading factor of a LoRa test frame to receive. If this value is set as ANY, RWC5020x receives any kind of SF packets

### **BW**

This parameter defines the bandwidth of a LoRa test frame to receive.

### **DATA RATE**

This parameter defines the data rate value for FSK modulation.

### **SYNC WORD SIZE**

This parameter defines the Sync word size for FSK modulation

### **SYNC WORD**

This parameter defines the Sync word for FSK modulation

### **RX POLARITY**

This parameter defines the RX signal polarity.

## **3.4.4 FUOTA Test**

The application provides a special function for LoRaWAN® FUOTA test. RWC5020x emulates gateway/FDS and the application controls RWC5020x. The system block diagram is as follows

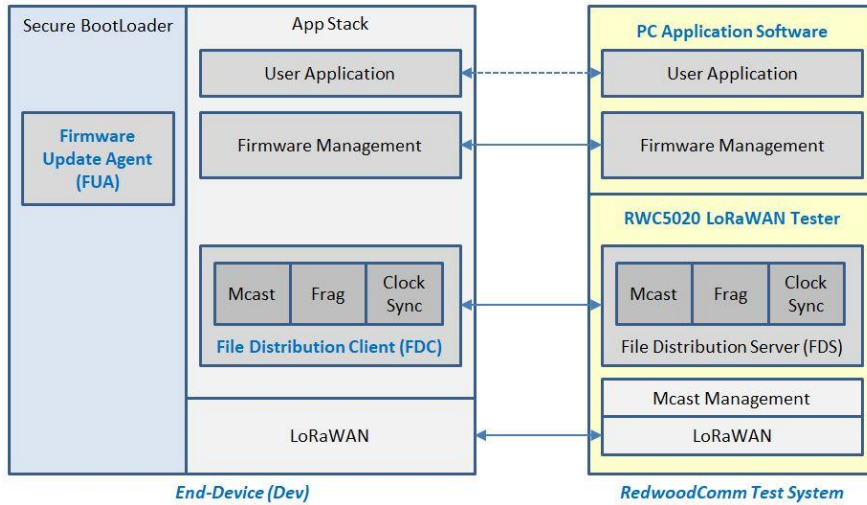

Fig 3.55 RedwoodComm test system for FUOTA Test

### 3.4.4.1 Test concept

Users can load the firmware binary file for FUOTA test. The application fragments, encodes, and transmits binaries to RWC5020x. Fragmentation parameters as well as Multicast parameters are editable using this GUI. The multicast function is optional. The clock Synchronization function will be performed automatically when Multicast function is selected.

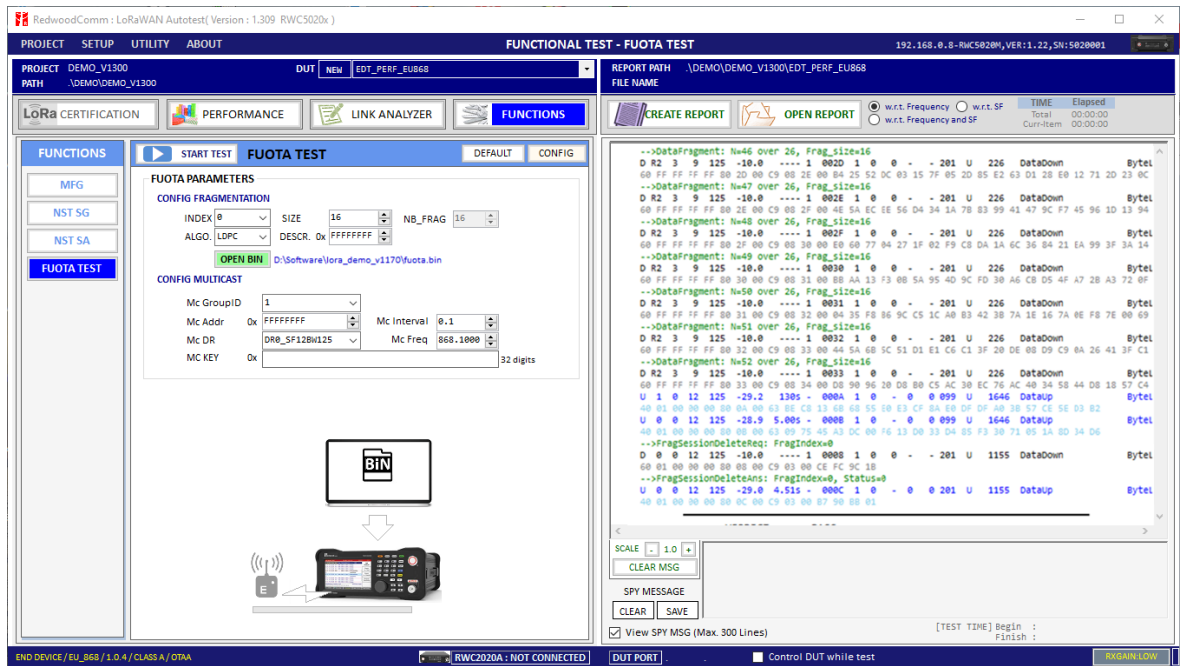

Fig 3.56 FUOTA test parameters and report window

#### 3.4.4.2 Fragmentation Parameters

##### **INDEX**

This value identifies one of the 4 fragmentation sessions possible simultaneously. RWC supports only one fragmentation at a time.

##### **SIZE**

This value is the size in byte of each fragment. The number of fragments will be calculated and displayed automatically.

##### **ALGORITHM**

The LoRa Alliance proposes LDPC as a simple Forward Error Correction (FEC) code to be used for fragmented transport of large binary files over LoRaWAN®.

##### **DESCRIPTOR**

This value is a freely allocated 4 byte field describing the file that is going to be transported through the fragmentation session.

#### 3.4.4.3 Multicast Parameters

##### **OPTION**

Select Unicast or Multicast method for FUOTA test.

##### **Mc Key**

Multicast Key value which will be distributed into the group of end-devices. The McAppSKey and McNetSKey are derived from the group's McKey.

##### **Mc GroupID**

An end-device may support being part of several multicast group simultaneously. Therefore, all multicast related command must always contain McGroupID of the multicast group being affected. RWC supports only one Multicast at a time.

##### **Mc Addr**

This value is the multicast group network address.

##### **Mc Freq**

This value is the frequency used for multicast.

**Mc Addr**

This value is the data rate used for multicast.

**Mc Interval**

This value is the interval between consecutive downlink messages within the multicast session to transmit user binary data.

3.4.4.4 Test Procedures

The message sequence charts are shown below for Multicast Test and Unicast Test respectively.

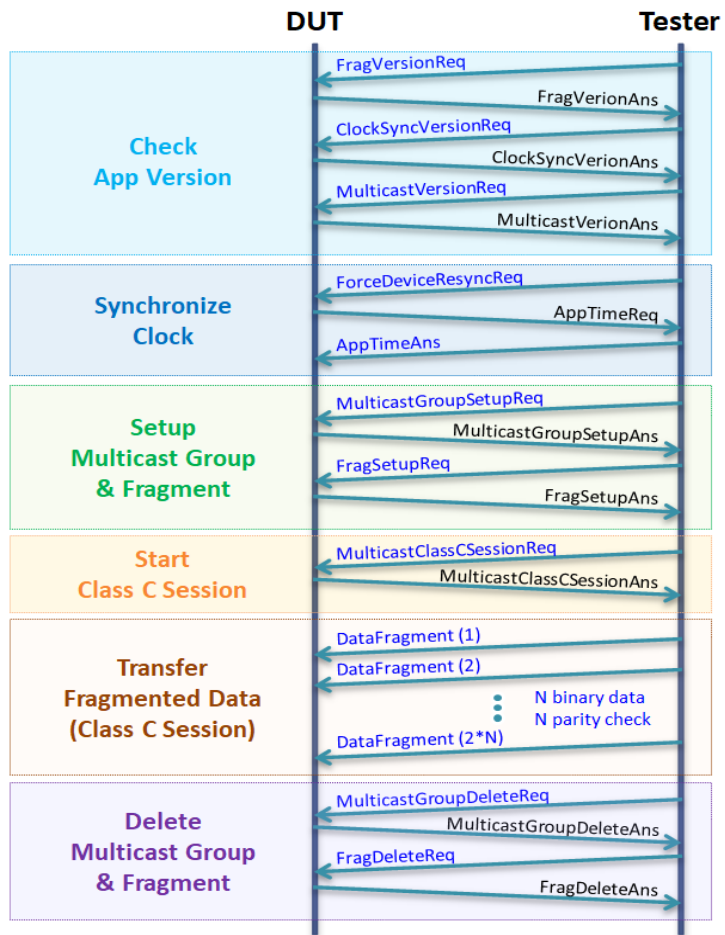

Fig 3.57 Multicast Test Procedure

## 3.5 Utilities

It consists of 3 utility functions: DUT Control, Tester(RWC5020x) Control, and Screen capture. You can find them on UTILITY menu tab at the top of the application.

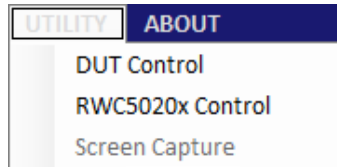

Fig 3.58 Utility menus

### 3.5.1 DUT Control

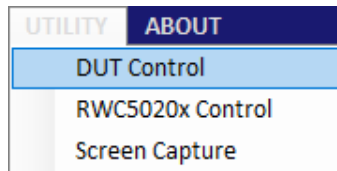



Fig 3.59 DUT control menu

This function is a simple terminal tool. It helps users control DUTs through RS232 using string command. Users can transmit DUT control commands all by one click or line-by-line.

#### 3.5.1.1 How to Use

You can type your own remote control commands and click  then it will transmit commands to RWC5020x sequentially. Users can use a special command SLEEP which lets PC wait for transmitting for the specified duration of time. The parameter of SLEEP is time in millisecond unit, e.g., SLEEP 1000 makes PC wait for 1000ms.

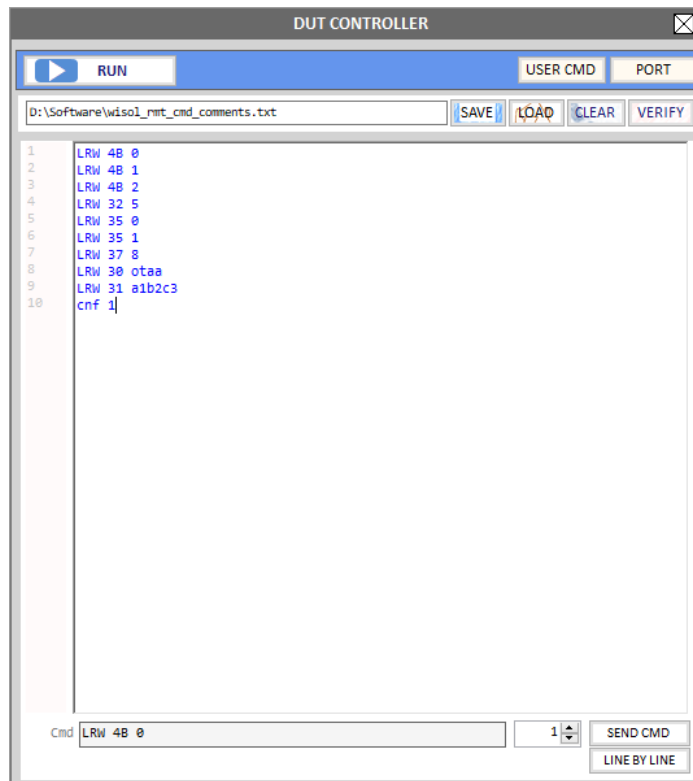

Fig 3.60 Sending commands of DUT Control function

### 3.5.1.2 Verify Commands

Clicking **VERIFY** will verify the commands on editor. Verifying criteria is based on the loaded user commands. Verified commands will be colored. The blue colored commands are user commands, and the grey colored ones are not user commands.

### 3.5.1.3 Transmission Methods

Clicking **RUN** will start transmitting commands. Transmitting commands will be stopped when you click **Stop** or once all commands are transmitted. Clicking **SEND CMD** will transmit the selected command. Clicking **LINE BY LINE** will transmit listed commands line by line.

## 3.5.2 RWC5020x Control

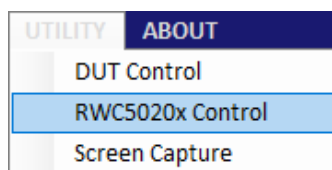



Fig 3.61 RWC5020x control menu

This function is a simple terminal tool. It helps users control RWC5020x through LAN using string command. Users can transmit RWC5020x remote commands all by one click or line-by-line.

### 3.5.2.1 How to Use

Clicking  will start transmitting commands on command window sequentially. Users can use a special command SLEEP, which will make the PC wait until the next command transmission is ordered. The parameter of SLEEP is time in millisecond unit, e.g., SLEEP 1000 makes PC wait for 1000ms.

### 3.5.2.2 Template

Template functions will fill the commands window with ready-made commands sequence as an example.

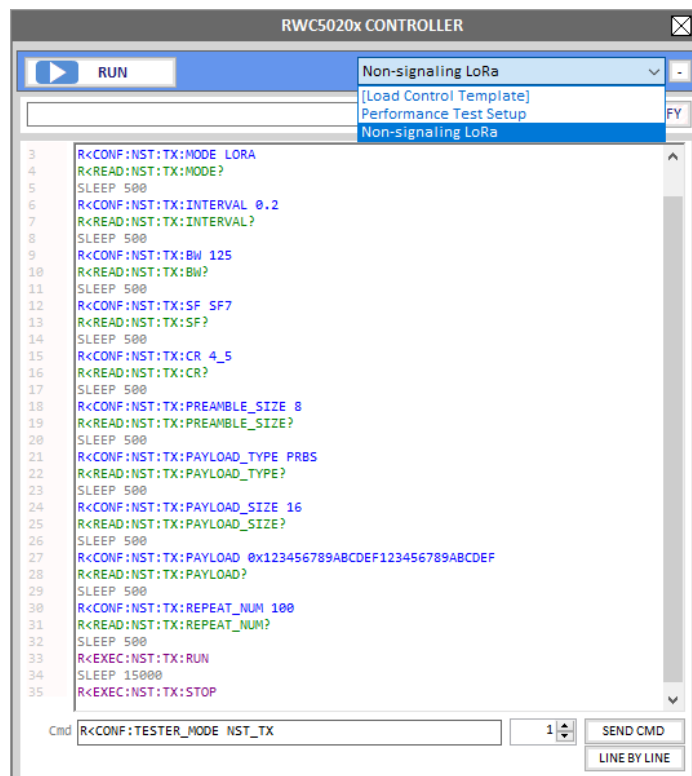

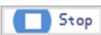
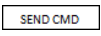
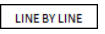

Fig 3.62 Sending commands of RWC5020x Control window

### 3.5.2.3 Sending commands

Clicking  will start transmitting commands. Transmitting commands will be stopped if you click  or once all commands are transmitted. Clicking  will transmit the selected command. Clicking  will transmit the listed commands line by line increasing the command number.

### 3.5.3 Screen Capture

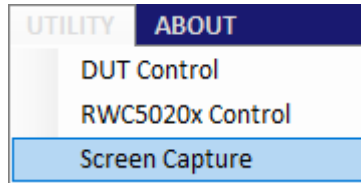
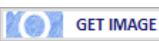

Fig 3.63 Screen capture menu

Clicking  will capture and show the current screen of the connected RWC5020x and save it as a bmp file. If you click one of the listed-up files on list window, the selected bmp file will be shown on image window. It will be enabled with RWC5020A and B but not with RWC5020M.

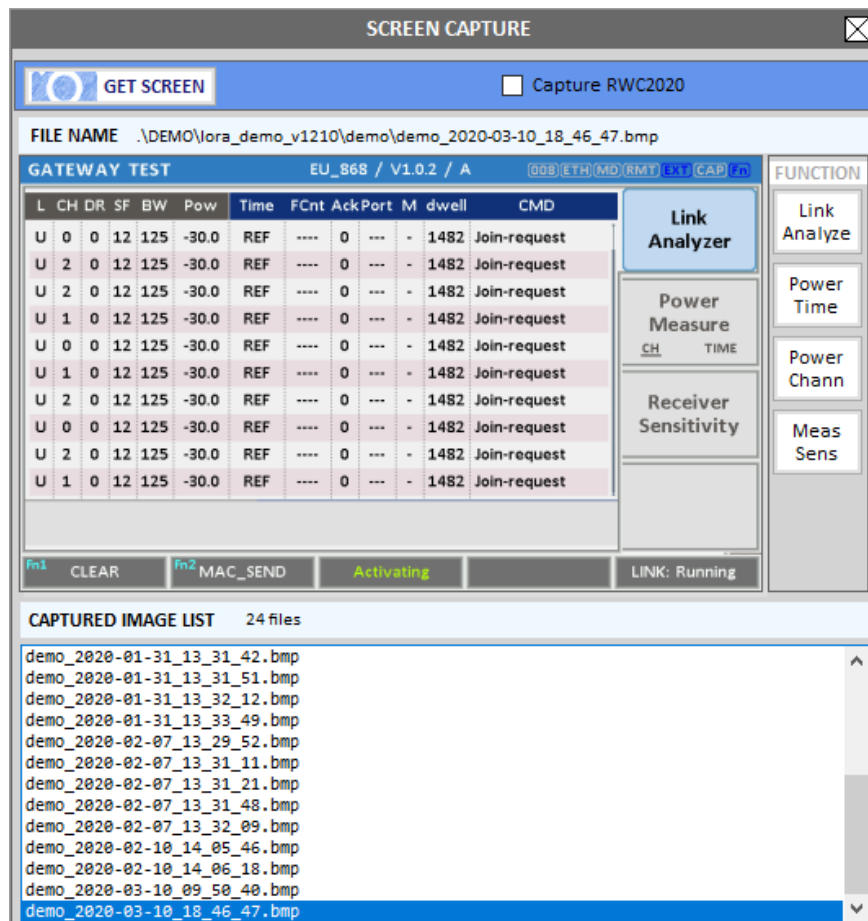

Fig 3.64 Screenshot of the RWC5020A/B



## IV. Report Functions

This chapter explains how to handle test reports for various kinds of test results. With report functions, users can see report messages while they test, create a report file after the test is finished and open it whenever users want to.

## 4.1 Report File Manager

### 4.1.1 Creating Report

Clicking  will open the save file window. You can change file name and save the result document. The result file will be saved as a word document.  will be enabled on Certification and Performance tab.

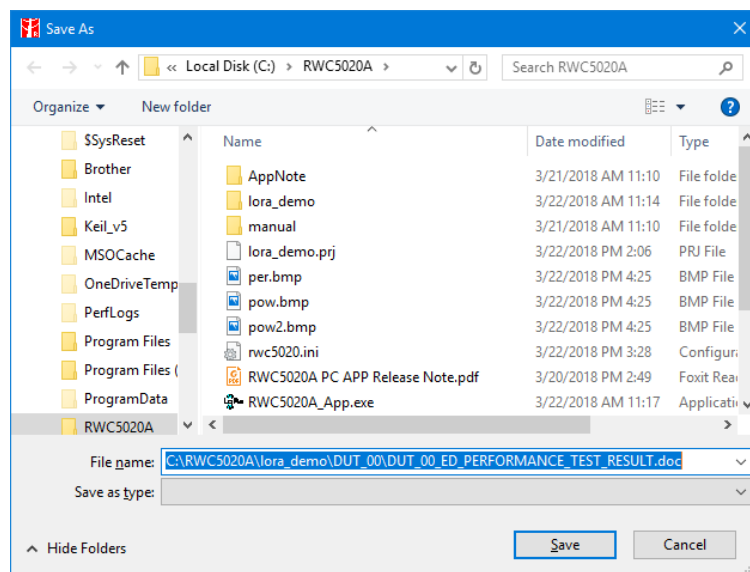

Fig 4.1 Creation of Test Report File

A Special report option will appear when NON-REGRESS test tab is selected.

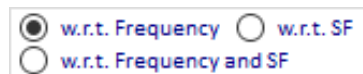

Fig 4.2 Report option menu for NON-REGRESS test

- w.r.t. Frequency** All NON-REGRESS test report will be created with respect to the tested frequency
- w.r.t. SF** All NON-REGRESS test report will be created with respect to the tested Spreading Factor
- w.r.t. Frequency and SF** All NON-REGRESS test report will be created with respect to both tested frequency and SF

After creating a report file, it will open automatically

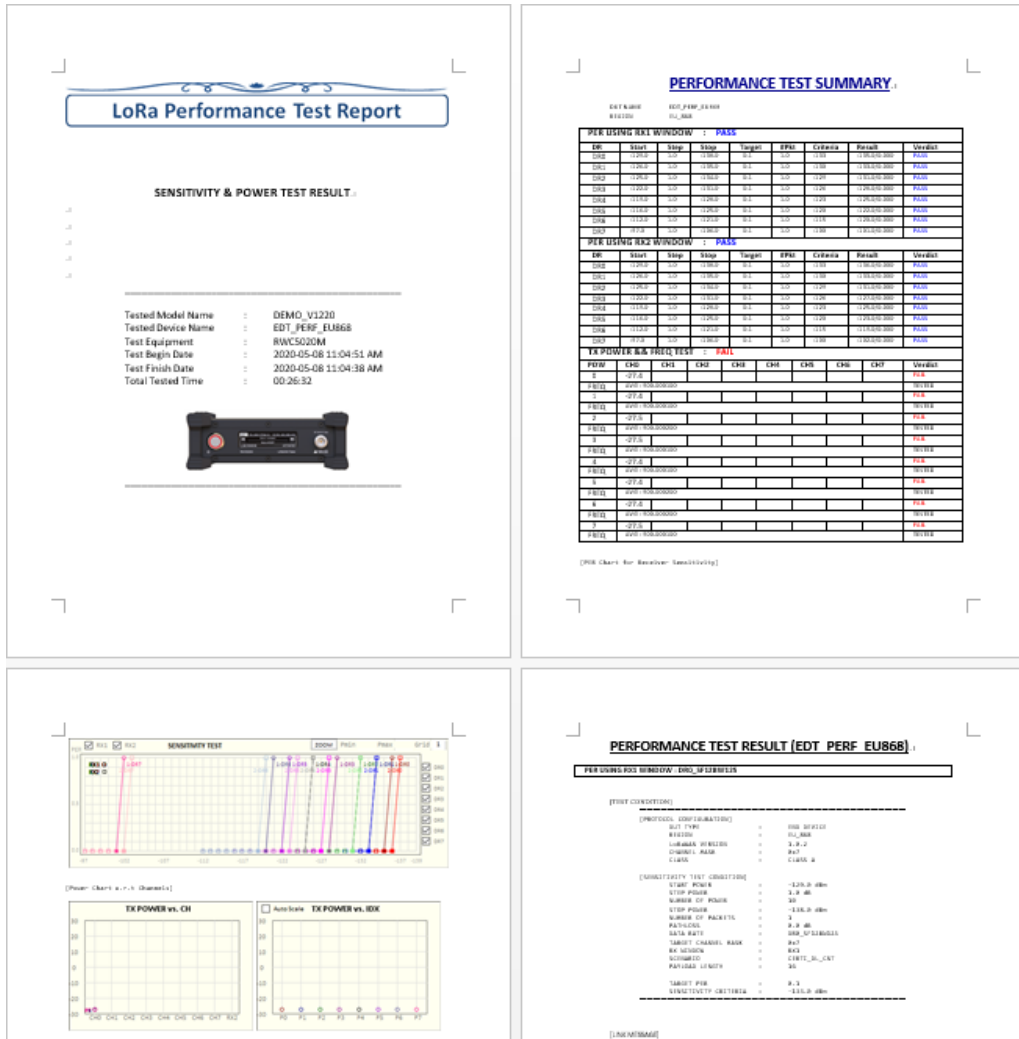

Fig 4.3 Created Report file (.doc)

### 4.1.2 How to Open the Saved Report File

Clicking will open a REPORT LIST window. Double clicking on a file name will open the selected file. The reading tool is Microsoft Word installed on your PC. This list window will show only the files existing on the same directory of DUT.

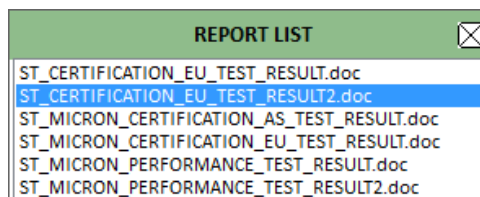

Fig 4.4 The List of test report files

---

**Headquarter**

#14008, OfficeSection Bldg, SK M-city, 195, Baengma-ro, Ilsandong-gu, Goyang-si, Gyeonggi-do, Korea  
+82-70-7727-7011

**Canada Branch**

Suite 206, 3711 Delbrook Ave, North Vancouver, BC V7N 3Z4, Canada  
+1-640-770-2688

E-mail [sales@RedwoodComm.com](mailto:sales@RedwoodComm.com)

Webpage <http://RedwoodComm.com/>

---